

KOMATSU®

FH35-2
FH40-2
FH45-2
FH50-2

Tier 4 Final Engine

DIESEL FORKLIFT TRUCK

FH SERIES



Photos may include optional equipment.

RATED CAPACITY

8,000 - 11,000 lb
3,625 - 4,975 kg

LOAD CENTER

24 in.
600 mm

WALK-AROUND

FH35-2 / FH40-2 / FH45-2 / FH50-2



FH50-2

Photos may include optional equipment.

RATED CAPACITY

FH35-2 : 8,000 lb (3,625 kg)
FH40-2 : 9,000 lb (4,075 kg)
FH45-2 : 10,000 lb (4,525 kg)
FH50-2 : 11,000 lb (4,975 kg)

LOAD CENTER

FH35-2 : 24 in. (600 mm)
FH40-2 : 24 in. (600 mm)
FH45-2 : 24 in. (600 mm)
FH50-2 : 24 in. (600 mm)

Ecology & Economy

- Komatsu's new diesel engine meets U.S. EPA Tier 4 Final standards **NEW**
- Fuel consumption is reduced by almost 30% in heavy duty cycle operations (Compared to the same class and capacity torque converter machine)

Workability & Durability

- Using field proven technologies used in Komatsu's construction machinery, the FH-2 features both "Electronically - controlled Hydro-Static Transmission (HST)" and "Variable displacement pump with Closed-center Load Sensing System (CLSS)"
- Komatsu's HST provides excellent controllability with maximized efficiency
- Komatsu designed & manufactured components offer exceptional durability and reliability

KOMTRAX

- KOMTRAX can communicate the machine's condition daily, which enables real-time remote fleet management and support to maximize fleet efficiencies
- Machine conditions are visible at a glance with the FH-2's large multi-function display **NEW**

Comfort & Efficiency

- Full suspension seat with ergonomic & efficient control layout
- Comfortable operator compartment reduces operator fatigue

KOMTRAX[®]



FH35-2



FH40-2



FH45-2

ECOLOGY & ECONOMY

KOMATSU NEW DIESEL ENGINE TECHNOLOGIES

Komatsu's new engine meets the U.S. EPA Tier 4 Final standard. **NEW**

The Komatsu SAA4D95LE-6 engine is U.S. EPA Tier 4 Final emission certified. It provides exceptional performance while reducing fuel consumption thanks to a Heavy-duty High-Pressure Common Rail fuel injection system and an electronic control system. Based on Komatsu proprietary technologies developed over many years, this new diesel engine reduces exhaust gas particulate matter (PM) by more than 90% as compared to the Tier 4 Interim levels. Engines, electronics and hydraulic components are all developed by Komatsu in-house and are designed to work cohesively. Komatsu has achieved great advancements in technology, providing high levels of performance and efficiency in virtually all applications.

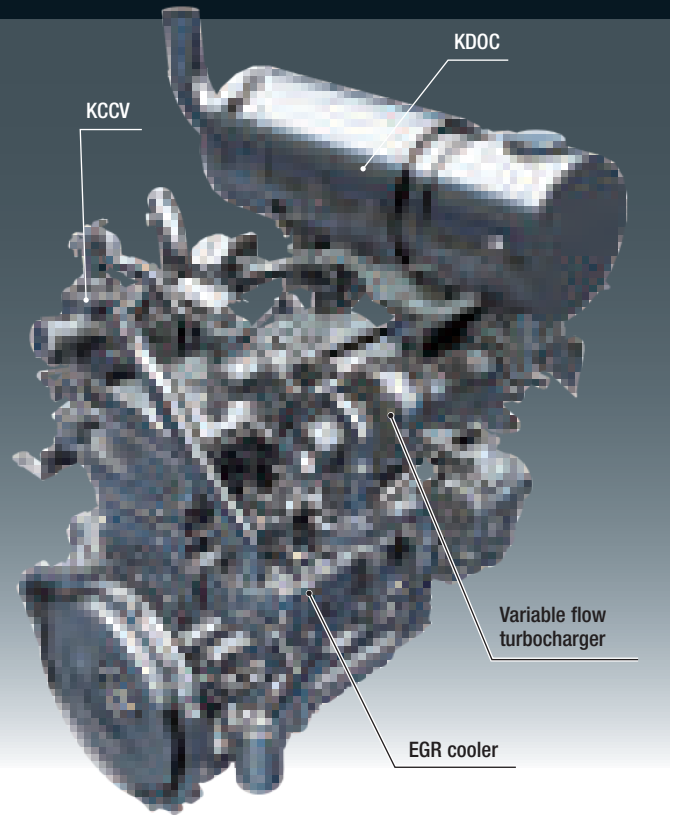

KOMATSU'S ADVANCED ENGINE TECHNOLOGIES

Komatsu Diesel Oxidation Catalyst (KDOC) **NEW**

Komatsu has developed a simple and highly efficient diesel oxidation catalyst, which reduces PM resulting in cleaner exhaust gas. Unlike a diesel particulate filter system, need for regeneration is eliminated, thus there is no excess maintenance required and there is no downtime for regeneration. A high performance silencer that contributes to the reduction of engine noise, is also integrated.

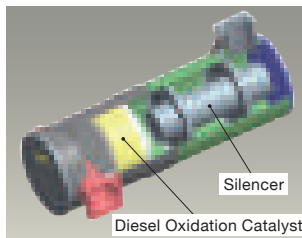

Cooled Exhaust Gas Recirculation (EGR) **NEW**

Cooled EGR system recirculates a portion of the exhaust gas for combustion and reduces NOx emissions, which results in cleaner exhaust gas.

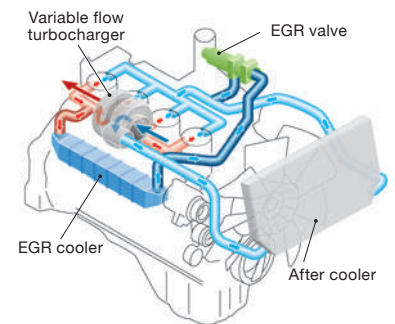

Variable Flow Turbocharger **NEW**

A newly designed variable flow turbocharger enables delivery of an optimal volume of air to the engine combustion chamber under all speed and load conditions. Exhaust turbine wheel speed is controlled by a flow control valve which controls air flow amount. The result is cleaner exhaust gas while maintaining engine power and performance.

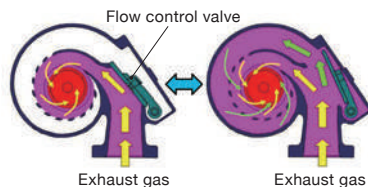

Komatsu Closed Crankcase Ventilation (KCCV) **NEW**

Crankcase emissions (Blowby gas) are passed through a KCCV filter. The filter then traps oil mist which is returned back to the crankcase for combustion. NOx emission is reduced, resulting in cleaner exhaust gas.



FH35-2 / FH40-2 / FH45-2 / FH50-2

Komatsu's Technologies Achieve Outstanding Fuel Efficiency With Low Emission Levels

The combination of CLSS high efficiency hydraulics and HST drive technology has proven to provide powerful performance with an almost 30% reduction on fuel consumption. There are no clutches which generate a loss in our HST, so engine output can be used effectively. The heavier duty the operation, the bigger the fuel saving benefit with Komatsu's FH-2 series.

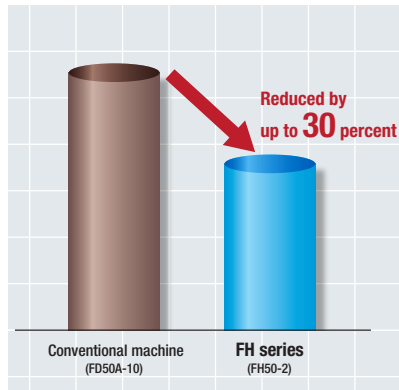

Reduced CO₂ Emission During High Load Work

The reduced fuel consumption enables reduced CO₂ emissions. In case of high load work, 10.7 ton/year CO₂ emission is reduced.

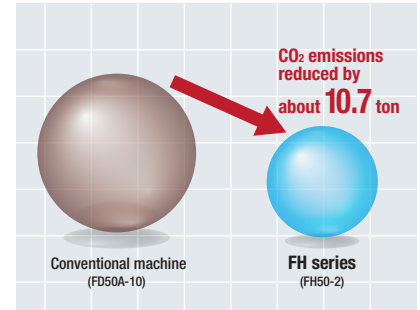

* Compared to the same class and capacity torque converter machine and when tested at our test course. Operation time: 5 hours/day, 300 days/year. The CO₂ emissions coefficient is calculated according to the guidelines (April 2006) shared by the Ministry of Economy, Trade and Industry and the Ministry of Land, Infrastructure, Transport and Tourism of Japan. In actual work, results may vary depending on the application.

30% Fuel Consumption Reduction (FH50-2)

* Compared to the same class and capacity torque converter machine and when tested at our test course. In actual work, results may vary depending on the application.

Auto Engine Shut Down Function

An auto engine shut down function is standard on the FH-2. This feature helps to prevent unnecessary fuel consumption caused by needless idling. (Engine shutdown time can be set from one minute to five minutes)

Variable Engine Output Control Function

The HST controller senses the weight of the load and automatically sends a signal to the engine electronic controlled modulation to control engine output. This helps balance necessary power and reduce fuel consumption.

Average Fuel Consumption and Current Fuel Consumption Level Indicator NEW

See support fuel-saving driving information on page 8.



WORKABILITY & DURABILITY

"Electronically - Controlled Hydro-Static Transmission (HST)" and "Variable Displacement Pump With Closed-Center Load Sensing System (CLSS)" Are Both Technologies That Have Been Field Proven For Many Years In Komatsu Wheel Loaders and Bulldozers.

The hydraulic lift system uses a "Variable displacement pump with CLSS", a highly efficient hydraulic system employed in Komatsu hydraulic excavators. All the components contribute to outstanding controllability as well as fuel savings and a reduced burden on the environment.



Electronically - Controlled HST

With the driving power being transmitted by pump and motor, the HST creates almost no power transmission loss.

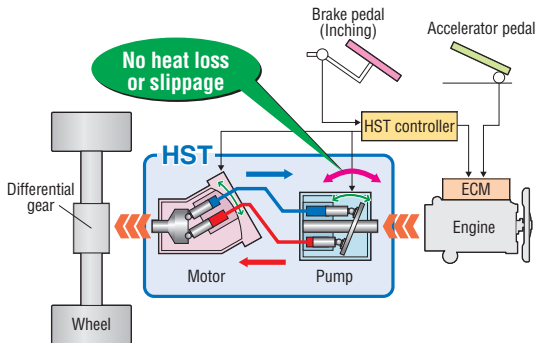

Conventional Torque Converter-Drive Forklift Truck

Transmission loss is created in the torque converter and the clutch respectively. Therefore a significant amount of loss occurs in the transmission.

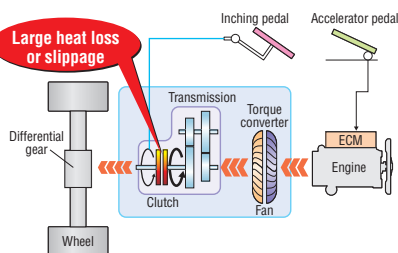

Variable Displacement Pump With CLSS

The pump supplies the exact amount of oil required by sensing the lifted load. No hydraulic loss in the circuit contributes to a reduction of fuel consumption.

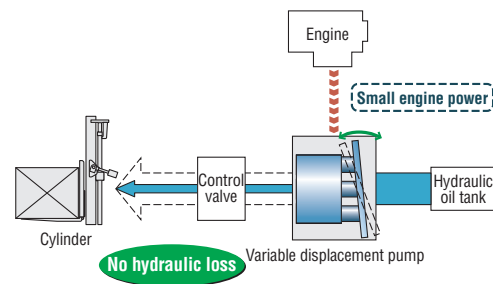

Conventional Fixed Displacement Gear Pump

Fixed displacement gear pumps deliver a specific amount of oil per rotation. Many times this delivers an excessive amount of oil and leads to added loading on the engine and added fuel consumption.

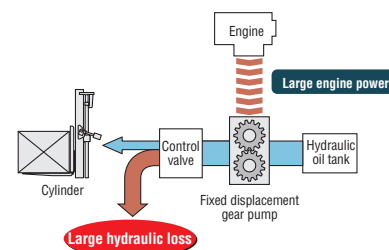

Shock-Free Shifting

The HST drive system has a continuously variable speed transmission that provides smooth acceleration and step-less ratio changes, thus there is less shock and reduced worries of loads shifting during operation.



Smooth Directional Changes Without Releasing The Accelerator Pedal

The engine is not mechanically connected to the drive system, but rather connected hydraulically to transmit tractive force. This makes it possible for the FH-2 series forklift trucks to make directional changes smoothly without releasing the accelerator pedal. This greatly enhances ease of operation.

*For proper operation, slow down before directional changes.



Higher Durability and Reliability With Komatsu Designed & Manufactured Components

All of the main components such as the engine, hydraulic pumps, hydraulic motor and the controller that controls these components are designed, developed and manufactured by Komatsu.

Controlled Rollback On A Ramp

The HST drive system has a self-braking feature which stops the flow of hydraulic fluid when the operator releases the accelerator pedal. This prevents uncontrolled rollback and holds the truck on a ramp while the operator releases the brake pedal for a ramp-start.



Precise and Secure Slow Speed Travel Control UPGRADE

Approaching and stopping for a cargo load at a very slow speed can be carried out smoothly by simply operating the accelerator pedal, resulting in less fatigue. Furthermore, this machine does not creep like conventional torque converter trucks even if the operator releases the brake pedal while the directional lever is in F or R position. This feature contributes to reduced risks in confined areas and when approaching to pick up a load.

* For proper operation, be sure to apply the parking brake when parking the forklift truck.



Enhanced Brake Reliability

With Komatsu HST, reducing the amount of oil flow to the hydraulic motor helps decelerate the forklift truck. This feature eases loading on the brakes, thus, enhancing brake reliability.

KOMTRAX

KOMTRAX Wireless Equipment Monitoring System

KOMTRAX, a standard feature on the FH-2, is Komatsu's remote equipment and fleet monitoring system. Leading-edge wireless technology and a secure, user-friendly, web-based application provide critical information; anytime, anywhere. KOMTRAX tells you where your machines are, what they are doing, and how they are doing it, providing total fleet management capabilities for improved fleet utilization, reduced downtime, and lower ownership and operating costs. KOMTRAX can help keep your machines operating at peak performance and provides useful information on operator habits and abilities. KOMTRAX also provides the information you need to maximize output through increased efficiencies, just-in-time maintenance, and preventative maintenance.

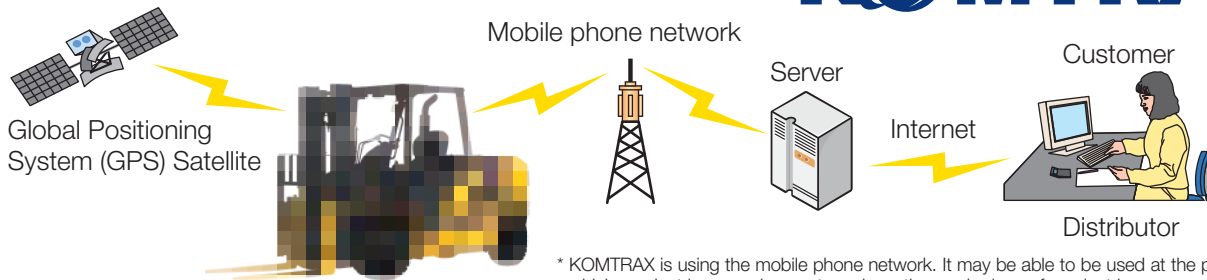

Machine Operation Information

Getting details of machine operation on a daily basis allows owners to analyze costs and take measures to reduce those costs as needed to improve their operations bottom line.

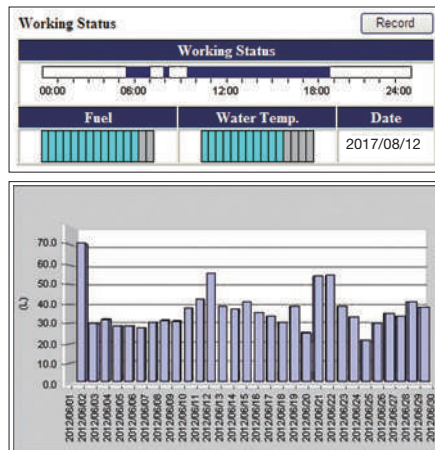

Operation Report

Daily, monthly and annual reports provide summaries of all critical data to help with fleet utilization analysis, scheduling and overall fleet management decisions.

Monthly Operation Report in Detail

Table with columns: Date, Machine No., Model, Type, Hours, and various performance metrics.

Machine Location Information

KOMTRAX uses a network of global positioning satellites to tell you where your machines are at all times. This can discourage or eliminate the possibility of theft or unapproved usage as well as providing necessary information for scheduling maintenance and operations management.

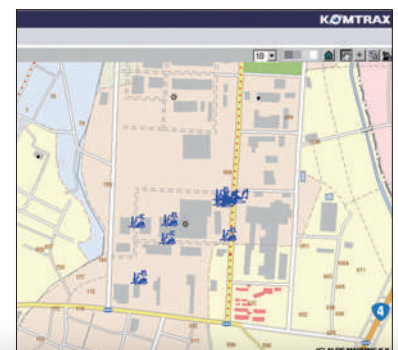

FH35-2 / FH40-2 / FH45-2 / FH50-2

LARGE HIGH RESOLUTION LCD MONITOR

Access machine condition at a glance with the large multi-function display **NEW**

The FH-2 features a large high resolution LCD dash mounted multi-function display so the operator can easily access machine conditions with a quick glance.

Truck speed and fuel economy can be viewed and more detailed information such as operation time and fuel consumption can be displayed via function buttons.



- 1 Hour Meter (Service Meter Readings (SMR)) Integration State
- 2 Parking Brake Indicator
- 3 Load Handling Interlock Indicator
- 4 Travel Interlock Indicator
- 5 KOMTRAX Message
- 6 Engine Coolant Temperature Indicator
- 7 HST Oil Temperature Indicator
- 8 Seat Belt Caution Indicator
- 9 Parking Brake Reminder Caution Lamp
- 10 Clock / Hour Meter (SMR) / Travel Distance (Odometer) Indicator / Caution Symbol
- 11 Current Travel Speed / Over Speed caution / Travel Speed (Tortoise) Set Indicator
- 12 Directional Lever Position
- 13 Preheating Pilot Indicator
- 14 Fuel Consumption Gauge / Load Checker
- 15 Fuel Gauge
- 16 Current Consumption Level Indicator
- 17 Guidance Icon
- 18 Function Button

Fuel Consumption

The display shows the machine's average fuel consumption as well as a gauge that shows current fuel consumption levels

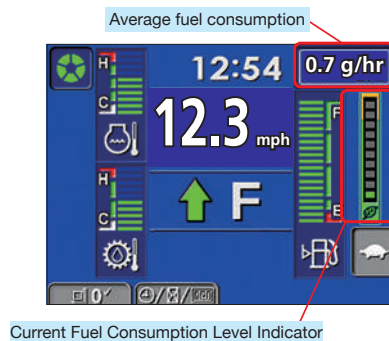

Fuel Consumption Record

The average fuel consumption history of the machine can be checked for the last twelve hours or for other selected time periods.



Maintenance History

The machine can record and track maintenance history, such as oil and filter changes, fuel filter changes and time remaining until the next required maintenance.



Operation Information Display

Operation information can be checked by pressing the function buttons.

- Working Hours
- Actual Fuel Consumption
- Average Fuel Consumption
- Actual Working Hours

Adjustable Performance Settings

The performance of the machine can be adjusted through the display panel to meet the needs of various operators and work sites

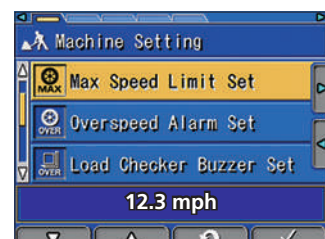

COMFORT & EFFICIENCY

OPERATOR FRIENDLY ACCESSORIES

Seat Belt Caution Indicator NEW

This warning alerts the driver when the seat belt is not fastened. Furthermore, the seat belt color is bright orange, ensuring that the seat belt is visible when in use.



KOPS Plus

The Komatsu Operator Presence Sensing system incorporates a Lifting/Traveling interlock function. This function disables traveling and lifting when the operator is not correctly in the seat. An alarm buzzer sounds if the operator leaves the seat while traveling.

* The traveling interlocking function only disengages traction and does not automatically apply the brakes.

Neutral Start Function

The FH-2 series engine will only start when the operator is in the seat, the directional lever is in the neutral position and the brake pedal is kept depressed.



Travel Speed Limiter

Travel speeds can be set in 3 stages. This function is useful to reduce speeds in tight spaces or to keep the forklift within specific in-plant speed limitations. (Set travel speed: 3, 5, 9 mph or OFF)

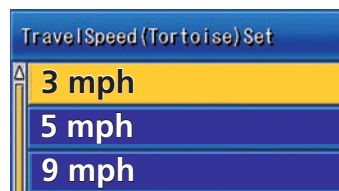

Lift Prevention When Key Is Off

When the key switch is off, the lift function is locked and assures that the fork and mast will not operate if the control lever is touched by accident, thus reducing risk.

Parking Brake Warning

If the driver gets off the machine without setting the parking brake, a warning light flashes and the buzzer intermittently sounds to prevent the parking brake from being forgotten. Also, if the driver steps on the acceleration pedal with the parking brake on, the buzzer sounds to prevent driving with the parking brake on.



FH35-2 / FH40-2 / FH45-2 / FH50-2

Load Checker With Buzzer NEW

A simple load checker that allows the cargo weight to be measured in 22 lb intervals is standard. If the load exceeds the set weight, the load checker sounds the buzzer to reduce the risk of exceeding the weight limit.

* This system is a reference for the operator, therefore cannot be used for commercial purposes.



Key Cylinder Cover

This standard feature protects the key switch from dirt and dust, thus enabling the truck to work reliably in dusty environments.



Speedometer and Overspeed Warning Buzzer NEW

The speedometer and the overspeed warning buzzer are equipped as standard. If the forklift's speed exceeds the set speed, the buzzer sounds to inform the operator he is traveling too fast.

* The warning buzzer can be set at intervals of .5 mph.

Locking Fuel Cap

A fuel cap with key is a standard feature that protects against stolen or contaminated fuel.



ID Key Enables Identification of The Operating Record (Optional)

An ID key is available as an option to enable individual operator accountability. Since the truck can only be operated using a registered ID key, it also serves as an effective means of theft prevention.

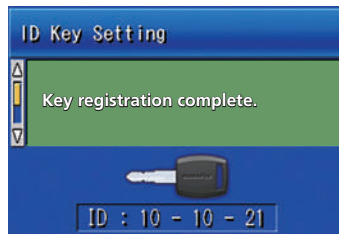

COMFORT & EFFICIENCY

Full Suspension Seat NEW

With a wider seat cushion and waist support, the operator can sit comfortably in the operating position. A large assist grip mounted on the left side facilitates easy entry and exit from the compartment. An ergonomic and efficient control layout, along with a spacious compartment design gives the operator a comfortable work space that reduces operator fatigue.



Upward Exhaust Muffler NEW

An upward exhaust muffler prevents dust on the road surface from being blown up into the operator compartment area.



Standard Equipment

Plastic overhead guard cover



Small diameter steering wheel (11.8 in.)



Large assist grip



Tilttable steering column

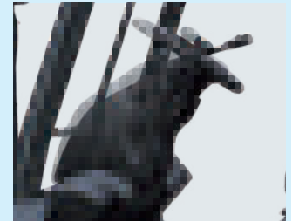

Parking brake lever (double action type)



LED Head lamps (with guard)



Paper binder on engine hood



Wide step



Hang down pedal and wide floor space



FH35-2 / FH40-2 / FH45-2 / FH50-2

EQUIPMENT

STANDARD EQUIPMENT

- Komatsu Diesel Engine - EPA Tier 4 Final Compliant
 - Heavy duty high pressure common rail system
 - Air to air charge air cooling system
 - Sedimentor with priming pump
 - Electronic engine control system
 - Overheat prevention function
 - Auto engine warm-up function
 - Auto air preheat function
- Cyclone air cleaner (double element)
- Auto engine shutdown function
- Variable engine output control function
- High efficiency fuel filter
- Variable displacement pump with CLSS
- Electronically-controlled HST
- Wet disc brakes
- Parking brake with release button (with parking brake reminder caution)
- 90.2 in. high overhead guard
- Plastic overhead guard cover
- Neutral start function
- Speed limiter function
- Operator presence sensing system
- Key-off lift lock
- Full suspension seat w/ orange belt
- Fully hydrostatic power steering
- Tilttable steering column
- Small diameter steering wheel with spinner knob
- Steering knob synchronizer function
- Standard directional lever
- Combination switch (turn signal lamp & lamp switch)
- Large LCD color display monitor
 - Engine coolant temperature indicator
 - Fuel gauge
 - Hour meter (SMR)
 - Preheating pilot indicator
 - Over speed caution
 - Parking brake indicator
 - Seat belt caution indicator
- Overspeed warning buzzer
- Paper binder on engine hood
- Floor mat
- Assist grip
- LED headlights & LED rear combination lights
- Upward exhaust pipe (Right side)
- 3-way control valve with port relief
- KOMTRAX®
- Sealed connectors
- Flat face-to-face O-ring seals
- Fuel cap with key
- Key cylinder cover
- Load checker (equipped with a buzzer)

TIRES:

- Front single drive, pneumatic
- Rear steer tires, pneumatic

FORKS:

- 42 in. (1,070 mm)

OPTIONAL EQUIPMENT

- Steel cab w/ heater and defroster
- Steel cab w/ heater, defroster and air conditioner
- Rear view mirror (center)
- Rear view mirror (pair)
- Tilt cylinder boots
- Power steering cylinder boots
- Air cleaner with pre-cleaner, inner fitting type
- Removable radiator screen & chassis under carriage protection (screen)
- Two front LED working lights, fender mounted
- Two front LED working lights, overhead guard mounted
- One rear LED working light, overhead guard mounted
- One rear LED working light, (backward when interlocked), overhead guard mounted
- Rotating LED light (yellow), overhead guard mounted
- Back up buzzer
- ID key
- TIRES:
 - Front, Single Drive, Solid Pneumatic
 - Front, Dual Drive, Pneumatic
 - Front, Dual Drive, Solid Pneumatic
 - Rear, Steer Tires, Solid Pneumatic
- FORKS:
 - 48 in. (1,220 mm)
 - 54 in. (1,370 mm)
 - 60 in. (1,520 mm)
 - 72 in. (1,820 mm)
 - 84 in. (2,120 mm)
 - 96 in. (2,440 mm)



SPECIFICATIONS

SPECIFICATIONS

Characteristics		Manufacturer's Designation		FH35-2	FH40-2	FH45-2	FH50-2	
1.2	Model	Electric, Diesel, Gasoline, LPG, Cable		Diesel	Diesel	Diesel	Diesel	
1.3	Power Type			Sitting	Sitting	Sitting	Sitting	
1.4	Operation Type							
1.5	Rated Capacity	Q	Rated Capacity	lb (kg)	8,000 (3,625)	9,000 (4,075)	10,000 (4,525)	11,000 (4,975)
1.6	Load Center	c	Rated Load Center	in. (mm)	24 (600)	24 (600)	24 (600)	24 (600)
1.8	Load Distance	x	Front Axle Center to Fork Face	in. (mm)	21.5 (545)	21.5 (545)	21.5 (545)	21.7 (550)
1.9	Wheelbase	y		in. (mm)	84.6 (2150)	84.6 (2150)	84.6 (2150)	84.6 (2150)
2.1	Service Weight			lb (kg)	13,426 (6,090)	14,065 (6,380)	14,980 (6,795)	15,873 (7,200)
2.2	Axle Loading	Loaded	Front	lb (kg)	19,081 (8,655)	20,492 (9,295)	21,925 (9,945)	23,578 (10,695)
2.2.1			Rear	lb (kg)	2,337 (1,060)	2,557 (1,160)	3,031 (1,375)	3,263 (1,480)
2.3		Unloaded	Front	lb (kg)	6,724 (3,050)	6,614 (3,000)	6,504 (2,950)	6,614 (3,000)
2.3.1			Rear	lb (kg)	6,702 (3,040)	7,452 (3,380)	8,477 (3,845)	9,259 (4,200)
3.1	Tire Type			Pneumatic	Pneumatic	Pneumatic	Pneumatic	
3.2	Tire Size	Front		300-15-18PR(I)	300-15-18PR(I)	300-15-18PR(I)	300-15-18PR(I)	
3.3		Rear		7.00-12-12PR(I)	7.00-12-12PR(I)	7.00-12-14PR(I)	7.00-12-14PR(I)	
3.5	Number of Wheel	Front/Rear (x=driven)		2x/2	2x/2	2x/2	2x/2	
3.6	Tread, Front	b10		in. (mm)	48.2 (1225)	48.2 (1225)	48.2 (1225)	48.2 (1225)
3.7	Tread, Rear	b11		in. (mm)	44.1 (1,120)	44.1 (1,120)	44.1 (1,120)	44.1 (1,120)
4.1	Tilting Angle	a / b	Forward/Backward	degree	6/12	6/12	6/12	6/12
4.2	Mast Height, Lowered	h1	2-stage Mast	in. (mm)	96.5 (2,450)	96.5 (2,450)	96.5 (2,450)	98.5 (2,500)
4.3	Std. Free Lift	h2	2-stage Std. Mast, from Ground	in. (mm)	6.9 (175)	6.9 (175)	6.9 (175)	6.9 (175)
4.4	Std. Lift Height	h3	2-stage Std. Mast, from Ground	in. (mm)	130 (3,300)	130 (3,300)	130 (3,300)	130 (3,300)
4.5	Mast Height, Extended	h4	2-stage Std. Mast	in. (mm)	178 (4,520)	178 (4,520)	178 (4,520)	178 (4,520)
4.7	Height, Overhead Guard	h6		in. (mm)	90.2 (2,290)	90.2 (2,290)	90.2 (2,290)	90.2 (2,290)
4.19	Length, with Std. Forks	L1		in. (mm)	168.1 (4,270)	169.9 (4,315)	171.5 (4,355)	171.7 (4,360)
4.20	Length, to Fork Face	L2		in. (mm)	126 (3,200)	127.8 (3,245)	129.3 (3,285)	129.5 (3,290)
4.21	Width, at Tire	b1	Single	in. (mm)	59.8 (1,520)	59.8 (1,520)	59.8 (1,520)	59.8 (1,520)
4.22	Forks	s/e/l	Thickness x Width x Length	in. (mm)	2.2 x 5.9 x 42.1 (50 x 150 x 1,070)	2.2 x 5.9 x 42.1 (50 x 150 x 1,070)	2.2 x 5.9 x 42.1 (50 x 150 x 1,070)	2.2 x 5.9 x 42.1 (50 x 150 x 1,070)
4.23	Fork Carriage Class	ISO 2328, Type A/B/no			class3, A	class3, A	class3, A	class4, A
4.24	Width, Fork Carriage	b3		in. (mm)	46.9 (1,190)	46.9 (1,190)	46.9 (1,190)	46.9 (1,190)
4.31	Ground Clearance	m1	Under Mast	in. (mm)	5.5 (140)	5.5 (140)	5.5 (140)	5.5 (140)
4.32		m2	at Center of Wheelbase	in. (mm)	8.3 (210)	8.3 (210)	8.3 (210)	8.3 (210)
4.33	Aisle Width *	Ast	with L1000 x W1200 pallet	in. (mm)	186.2 (4,730)	187.4 (4,760)	188.2 (4,780)	189.6 (4,815)
4.34		Ast	with L1200 x W800 pallet	in. (mm)	191.3 (4,860)	192.5 (4,890)	193.3 (4,910)	196.7 (4,995)
4.35	Turning Radius	Wa		in. (mm)	114.8 (2,915)	115.9 (2,945)	116.7 (2,965)	117.9 (2,995)
5.1	Travel Speed (FWD)	Loaded		mph (km/h)	14 (22.5)	14 (22.5)	14 (22.5)	14 (22.5)
		Unloaded		mph (km/h)	14.6 (23.5)	14.6 (23.5)	14.6 (23.5)	14.6 (23.5)
5.2	Lifting Speed	Loaded		fpm (mm/s)	96.5 (490)	95.5 (485)	82.7 (420)	82.7 (420)
		Unloaded		fpm (mm/s)	99.4 (505)	99.4 (505)	86.6 (440)	86.6 (440)
5.3	Lowering Speed	Loaded		fpm (mm/s)	98.4 (500)	98.4 (500)	98.4 (500)	98.4 (500)
		Unloaded		fpm (mm/s)	98.4 (500)	98.4 (500)	98.4 (500)	98.4 (500)
5.6	Max. Drawbar Pull	Loaded 1.5 km/h, 3 min rating		lb (kN)	7,644 (34)	7,644 (34)	7,644 (34)	7,867 (35)
5.8	Max. Gradeability	Loaded 1.5 km/h, 3 min rating		%	33	33	29	28
5.10	Service Brake	Operation/Type			Foot/Hydraulic	Foot/Hydraulic	Foot/Hydraulic	Foot/Hydraulic
5.11	Parking Brake	Operation/Control			Hand/Mechanical	Hand/Mechanical	Hand/Mechanical	Hand/Mechanical
5.12	Steering	Type			FHPS	FHPS	FHPS	FHPS
6.4	Battery	Voltage/Capacity at 5-hour rating		V/Ah	2 x 12/52	2 x 12/52	2 x 12/52	2 x 12/52
7.1	Make				KOMATSU	KOMATSU	KOMATSU	KOMATSU
	Model				SAA4D95LE-6-C	SAA4D95LE-6-C	SAA4D95LE-6-C	SAA4D95LE-6-C
7.2	Rated Output, SAE net			HP (kW)	66.4 (49.5)	66.4 (49.5)	66.4 (49.5)	66.4 (49.5)
7.3	Rated RPM			min-1	2,150	2,150	2,150	2,150
7.3.1	Max. Torque, SAE net			lb-ft (Nm) @ rpm	212 (287) @ 1,400	212 (287) @ 1,400	212 (287) @ 1,400	212 (287) @ 1,400
7.4	No. of Cylinder/Displacement			Cu. In. (cm ³)	4/199 (3,260)	4/199 (3,260)	4/199 (3,260)	4/199 (3,260)
7.6	Fuel Tank Capacity			US Gallons (L)	27.7 (105)	27.7 (105)	27.7 (105)	27.7 (105)
8.2	Relief Pressure for Attachment			PSI (Mpa)	2,988 (20.6)	2,988 (20.6)	2,988 (20.6)	2,988 (20.6)
8.2.1	Hydraulic tank Capacity			Gallons (L)	20.1 (76)	20.1 (76)	20.1 (76)	20.1 (76)
8.7	Transmission				Hydrostatic	Hydrostatic	Hydrostatic	Hydrostatic

* : VDI 2198 includes 7.9 in. (200 mm) clearance

LOAD CAPACITY CURVE

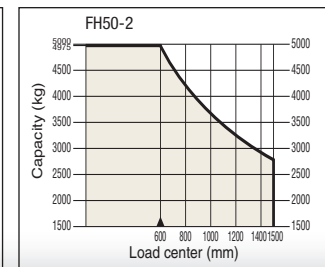
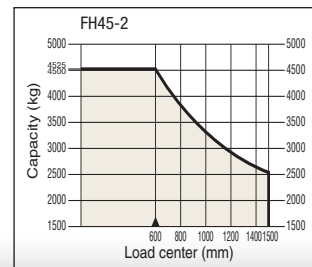
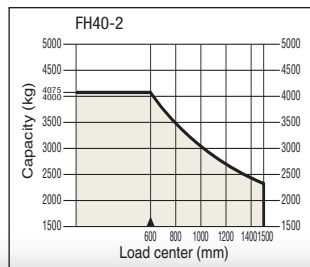
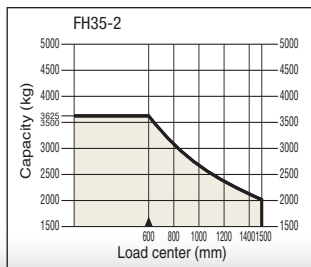

FH35-2 / FH40-2 / FH45-2 / FH50-2

DIMENSIONS

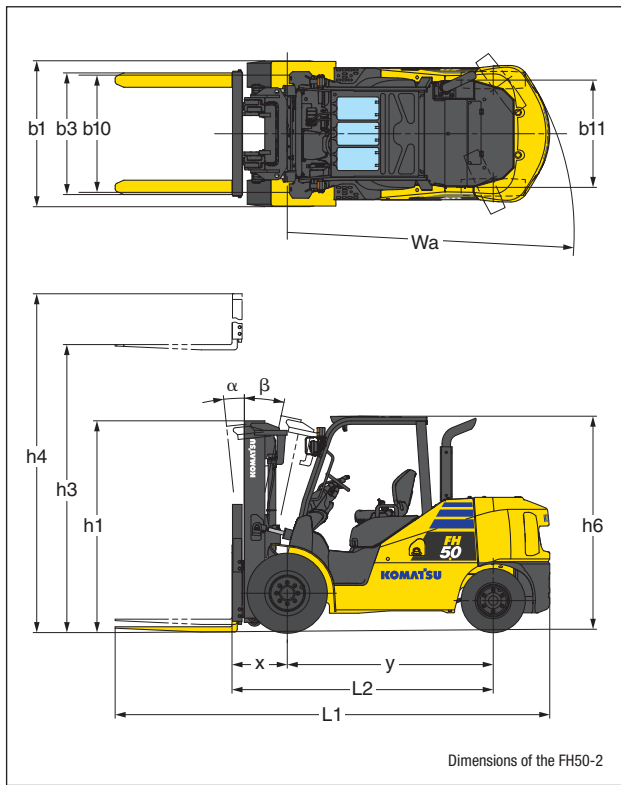

AISLE WIDTH

Model	Length of pallet: in. (mm)	Width of pallet: in. (mm)	
		31.5 (800) - 55.1 (1,400)	
FH35-2	31.5 (800)	186.2 (4,730)	
	35.4 (900)	186.2 (4,730)	
	39.4 (1,000)	186.2 (4,730)	
	43.3 (1,100)	187.4 (4,760)	
	47.2 (1,200)	191.3 (4,860)	
	51.2 (1,300)	195.3 (4,960)	
FH40-2	55.1 (1,400)	199.2 (5,060)	
	31.5 (800)	187.4 (4,760)	
	35.4 (900)	187.4 (4,760)	
	39.4 (1,000)	187.4 (4,760)	
	43.3 (1,100)	188.6 (4,790)	
	47.2 (1,200)	192.5 (4,890)	
FH45-2	51.2 (1,300)	196.5 (4,990)	
	55.1 (1,400)	200.4 (5,090)	
	31.5 (800)	188.2 (4,780)	
	35.4 (900)	188.2 (4,780)	
	39.4 (1,000)	188.2 (4,780)	
	43.3 (1,100)	189.4 (4,810)	
FH50-2	47.2 (1,200)	193.3 (4,910)	
	51.2 (1,300)	197.2 (5,010)	
	55.1 (1,400)	201.2 (5,110)	
	31.5 (800)	189.6 (4,815)	
	35.4 (900)	189.6 (4,815)	
	39.4 (1,000)	189.6 (4,815)	
FH50-2	43.3 (1,100)	190.7 (4,845)	
	47.2 (1,200)	194.7 (4,945)	
	51.2 (1,300)	198.6 (5,045)	
	55.1 (1,400)	202.6 (5,145)	

MAXIMUM LOAD AND OVERALL HEIGHT OF MAST BY LIFTING HEIGHT

2-stage Free View Mast (single tire, load center 24 in. (600 mm))

Maximum Fork Height: in. (mm)		Load Capacity: lb (kg)*				Overall Height [Lowered / Extended]: in. (mm)	
FH35-2 - FH45-2	FH50-2	FH35-2	FH40-2	FH45-2	FH50-2	FH35-2 - FH45-2	FH50-2
119 (3,025)	119 (3,025)	8,000 (3,625)	9,000 (4,075)	10,000 (4,525)	11,000 (4,975)	90.5 (2,300) / 167 (4,240)	92.5 (2,350) / 167 (4,240)
*130 (3,300)	*130 (3,300)	8,000 (3,625)	9,000 (4,075)	10,000 (4,525)	11,000 (4,975)	*96.5 (2,450) / 178 (4,520)	*98.5 (2,500) / 178 (4,520)
138 (3,500)	138 (3,500)	8,000 (3,625)	9,000 (4,075)	10,000 (4,525)	11,000 (4,975)	100.5 (2,555) / 186 (4,725)	102.5 (2,605) / 186 (4,725)
146 (3,700)	146 (3,700)	8,000 (3,625)	9,000 (4,075)	10,000 (4,525)	11,000 (4,975)	104.5 (2,655) / 194 (4,930)	106.5 (2,705) / 194 (4,930)
158 (4,000)	159 (4,025)	8,000 (3,625)	9,000 (4,075)	10,000 (4,525)	11,000 (4,975)	110.5 (2,805) / 206 (5,230)	113.5 (2,885) / 207 (5,260)
177 (4,500)	177 (4,500)	8,000 (3,625)	9,000 (4,075)	10,000 (4,525)	11,000 (4,975)	120.5 (3,060) / 225 (5,715)	122.5 (3,110) / 225 (5,715)

3-stage full free view mast (single tire, load center 24 in. (600 mm), 3-cylinder type)

Maximum Fork Height: in. (mm)		Load capacity: lb (kg)*				Overall height [Lowered / Extended]: in. (mm)	
FH35-2 - FH45-2	FH50-2	FH35-2	FH40-2	FH45-2	FH50-2	FH35-2 - FH45-2	FH50-2
146 (3,700)	148 (3,750)	8,000 (3,625)	9,000 (4,075)	10,000 (4,525)	10,585 (4,800)	79.5 (2,020) / 194 (4,930)	82.5 (2,095) / 196 (4,980)
158 (4,000)	157 (3,975)	8,000 (3,625)	9,000 (4,075)	10,000 (4,525)	10,140 (4,600)	83.5 (2,120) / 206 (5,230)	85.5 (2,170) / 205 (5,205)
170 (4,300)	170 (4,300)	7,459 (3,400)	9,000 (4,075)	9,700 (4,400)	10,140 (4,600)	87.5 (2,225) / 218 (5,535)	89.5 (2,275) / 218 (5,535)
179 (4,525)	179 (4,525)	6,615 (3,000)	9,000 (4,075)	9,370 (4,250)	9,920 (4,500)	90.5 (2,300) / 227 (5,765)	92.5 (2,350) / 227 (5,765)
185 (4,700)	185 (4,700)	5,510 (2,500)	8,380 (3,800)	9,260 (4,200)	9,920 (4,500)	92.5 (2,350) / 233 (5,920)	94.5 (2,400) / 233 (5,920)
197 (5,000)	197 (5,000)	5,290 (2,400)	7,715 (3,500)	9,040 (4,100)	9,040 (4,100)	96.5 (2,450) / 245 (6,225)	98.5 (2,500) / 245 (6,225)

* Load capacity is approximate. Please refer to your forklift's data plate for actual capacity on your specific machine.

We're Close By

Komatsu Forklift U.S.A. has a dealer network covering all regions of the United States and Canada. So, it doesn't matter where you are located, a Komatsu Forklift U.S.A. dealer will be there ready to provide the quality service and solutions you need.



FH35-2 / FH40-2 / FH45-2 / FH50-2

KOM99-01

©2018 Komatsu America Corp.

Printed in USA

AD01(2.5M)OTP

01/18(EV-1)

KOMATSU®

Note: All comparisons and claims of improved performance made herein are made with respect to the prior Komatsu model unless otherwise specifically stated.

www.KomatsuAmerica.com

www.KomatsuForkliftUSA.com

Komatsu America Corp. is an authorized licensee of Komatsu Ltd. Materials and specifications are subject to change without notice. Photos may include optional equipment.

KOMATSU® and KOMTRAX® are registered trademarks of Komatsu Ltd.

All other trademarks and service marks used herein are the property of Komatsu Ltd., Komatsu America Corp. or their respective owners or licensees.