



# PC78US-11

Compact hydraulic excavator Tier 4 Final engine



Photos in this brochure may include optional equipment

### Net horsepower

68 HP @ 1,850 rpm  
(51 kW @ 1,850 rpm)

### Operating weight

17,439-18,188 lbs.  
(7,910-8,250 kg)

### Bucket capacity

0.12-0.26 yd<sup>3</sup>  
(0.09-0.20 m<sup>3</sup>)

# Walk-around



Efficiency



Reliability



Productivity

## Net horsepower

68 HP @ 1,850 rpm  
(51 kW @ 1,850 rpm)

## Operating weight

17,439-18,188 lbs.  
(7,910-8,250 kg)

## Bucket capacity

0.12-0.26 yd<sup>3</sup>  
(0.09-0.20 m<sup>3</sup>)



## Performance and versatility

Rugged Komatsu-designed front work equipment, long undercarriage and a powerful swing system are designed to deliver high performance in demanding job site applications. A spacious cab with all-LED lighting provides a comfortable operator working environment. Enhanced controller logic and new Tier 4 Final engine technology deliver excellent performance and fuel efficiency.

**A high-output Komatsu SAA3D95E-1 engine** provides a net output of 68 HP (50.6 kW). This engine is EPA Tier 4 Final emissions certified.

**Viscous fan clutch** helps improve fuel efficiency when maximum fan speed is not required.

**Komatsu Diesel Oxidation Catalyst (KDOC)** reduces particulate matter using passive regeneration 100% of the time. No AdBlue/DEF or DPF is required.

**Komatsu's closed-center load sensing system (CLSS)** provides quick response and smooth operation to promote maximum productivity.

**Enhanced working modes** are designed to match engine speed, pump delivery and system pressure to the application.

#### **Large LCD color monitor panel**

- 7-inch high-resolution screen
- Provides "ecology guidance" for fuel-efficient operation
- Enhanced attachment control

#### **Rearview monitoring system (standard)**

**Equipment Management Monitoring System (EMMS)** continuously monitors machine operation and vital systems to identify machine issues and assist with troubleshooting.

#### **Enhanced working environment**

- High-back suspension operator seat
- Integrated ROPS cab design
- Cab meets ISO Level 1 Operator Protective Guard (OPG) top guard
- Auxiliary jack and two (2) 12V outlets

**Ultra-short swing radius** and conventional style boom allows the PC78US-11 to easily operate in confined spaces.

**Proportional control of the attachment circuit on the joystick handles.** Standard auxiliary attachment circuit piping includes shut off valves at end of the arm.

**Battery disconnect switch** allows a technician to disconnect the power supply before servicing the machine.

#### **Komatsu designed and manufactured components**

**Large service doors** help improve maintenance accessibility with centralized ground-level filters relocated to a common area.

**Komatsu Auto Idle Shutdown** helps reduce idle time and operating costs.

**Standard 7 ft. 7 in (2,330 mm) blade** redesigned to roll material for more efficient backfilling.

#### **Standard pattern change valve**

#### **Bluetooth radio with wireless technology and USB**

**LED work lamps** are standard equipment.



All comparisons are made with respect to the prior Komatsu model unless otherwise specifically stated.

# Performance features

## Komatsu new engine technologies

### A new high-output 2.4-liter engine

Komatsu's new, in-house-developed high-output 2.4-liter engine is designed to help meet user requirements. Its digging efficiency and environmental performance are top-of-the-class, offering high power and low fuel consumption with a compact engine. Centralized ground-level access filters help reduce maintenance time.

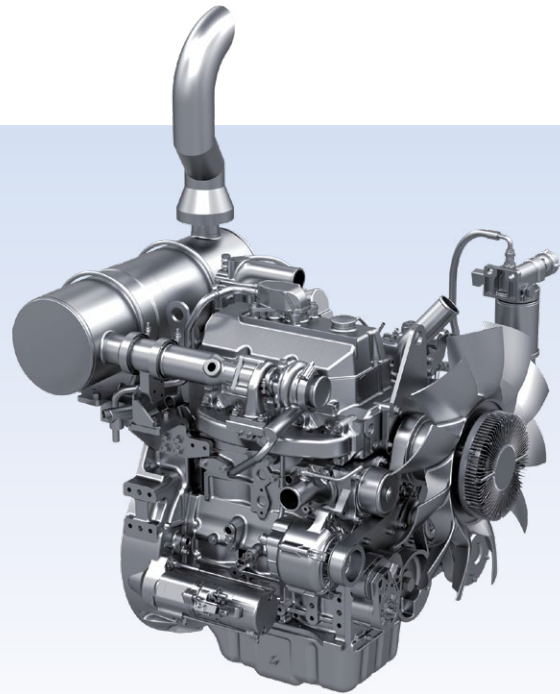

## Improved efficiency

Improved total vehicle control promotes optimum performance under a wide variety of operational conditions. Improvements such as variable speed matching of engine speed according to hydraulic pump output, reduction of hydraulic pressure loss and a fan clutch help significantly reduce fuel consumption, while enabling higher operating speeds.



Compared to the PC78US-11

## New engine technologies

### Electronic control system

Adapt to your conditions with an electronic control system that adjusts the machine's behavior based on the operator's actions and terrain. Stay informed and work effectively with engine and machine updates on the in-cab monitor. Monitor and manage your work equipment data with Komtrax to help enhance performance and optimize usage.

### Heavy-duty, high-pressure common rail fuel injection system

This system is designed to deliver fuel precisely and efficiently to the engine's combustion chambers at extremely high pressure to help decrease particulate matter (PM) emissions and nitrogen oxide. With efficient combustion, this system also helps promote a reduction in fuel consumption.

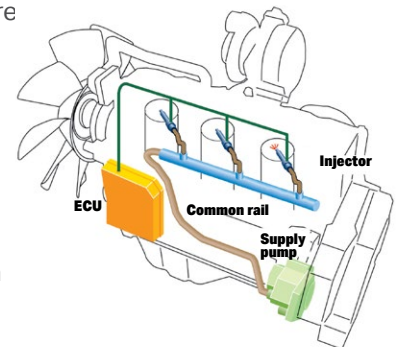

### Komatsu Diesel Oxidation Catalyst (KDOC)

The Komatsu Diesel Oxidation Catalyst (KDOC) has an integrated design that does not interfere with daily operation. This smart and simplified system removes soot using 100% passive regeneration without the need for a Diesel Particulate Filter. The KDOC has a low-maintenance design that helps contribute to reduced operating costs due to fewer complexities and a more seamless operation.

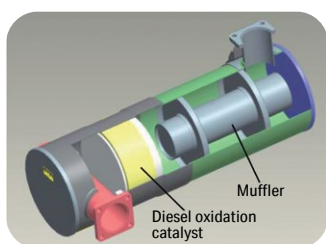

### Cooled exhaust gas recirculation (EGR)

Work effectively with a cooled EGR system designed to reduce nitrogen oxide emissions and enhance performance during demanding work conditions.

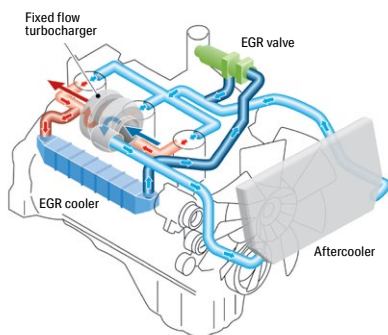

### Low noise with variable matching control

A compact engine creates room for a fan clutch system, enabling the engine and hydraulic system turning through variable matching control system to reduce noise.

#### Surrounding noise

**Reduced 1.0 dbA**

Compared to the PC78US-11

### Adapt with working mode selection

The PC78US-11 excavator is equipped with six working modes (P, E, L, B, ATT/P and ATT/E). Each mode is designed to match engine speed, pump flow and system pressure to the application. The PC78US-11 features a new mode (ATT/E) which allows operators to run attachments while in "economy" mode.

Working Mode	Application	Advantage
<b>P</b>	Power mode	<ul style="list-style-type: none"> <li>•Maximum production/power</li> <li>•Fast cycle times</li> </ul>
<b>E</b>	Economy mode	<ul style="list-style-type: none"> <li>•Good cycle times</li> <li>•Better fuel economy</li> </ul>
<b>L</b>	Lifting mode	<ul style="list-style-type: none"> <li>•Increases hydraulic pressure</li> </ul>
<b>B</b>	Breaker mode	<ul style="list-style-type: none"> <li>•Optimized engine rpm, hydraulic flow</li> </ul>
<b>ATT/P</b>	Attachment Power mode	<ul style="list-style-type: none"> <li>•Optimized engine rpm, hydraulic flow, 2-way</li> <li>•Power mode</li> </ul>
<b>ATT/E</b>	Attachment Economy mode	<ul style="list-style-type: none"> <li>•Optimized engine rpm, hydraulic flow, 2-way</li> <li>•Economy mode</li> </ul>

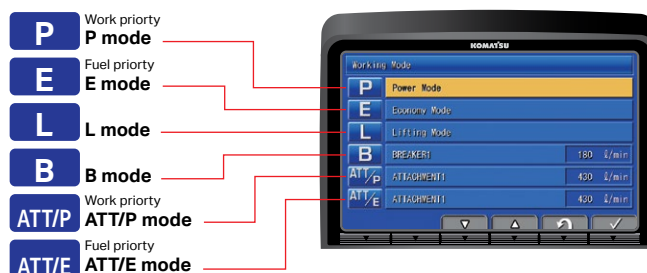

### Working mode selectable

### Ecology gauge and fuel consumption gauge

### Ecology guidance

### Auto-decelerator

# Performance features

## Complete tasks quickly and effectively

Get fast cycle times with high digging speed performance, driven by efficient arm and bucket forces. High arm crowd and bucket curl forces make it easier to work in tough digging conditions. The smooth integration of multiple operational controls allows operators to have precise control over the excavator's movements for enhanced performance.

### Productivity (90-degree dump loading)

**P mode** up to **8%** increase

Compared to the PC78US-11

## Enhanced operator awareness

Strategically placed LED lamps on the boom and cab help improve operator visibility in low-light conditions.



Photo may include optional equipment.



## Tackle a wide range of tasks with smooth multifunction operation

Quick arm speed helps make leveling work easy and fast. Get jobs done faster with improved combined hoist and swing speed.

### Move and distribute materials with ease

Handle a wide range of tasks on the job site with this excavator's improved blade design. Roll materials fast for efficient dozing work and backfilling.

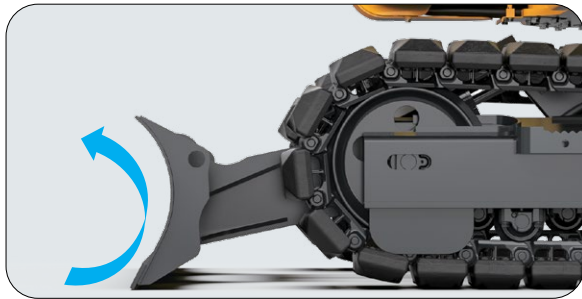

### Enhance your operational efficiency

The travel speed selector on blade lever allows operators to engage high-speed travel without removing hands from the controls. Travel speed automatically shifts up or down within the selected speed range.



Travel switch

### Equipped with a blade as standard equipment

A blade for efficient backfilling and leveling work is equipped as standard.



### Versatility to up your productivity

Accommodate a broad range of attachments to expand application versatility with an auxiliary hydraulic circuit that provides up to a 12% increase\* in hydraulic flow.

#### Hydraulic flow to the attachment

up to **12%**

\*Compared to the PC778US-11

### Programmable attachment memory

Simplify and expedite the process of changing between hydraulic attachments. Equipped with universal piping for attachments such as breakers or crushers, just push the breaker mode switch on the monitor to convert to low-pressure (one-way flow) mode.



# Maintenance features

## Maintenance made easier

Larger and more access doors improve the ability to get to important components and areas for inspection, repairs or routine maintenance.

- 1. Easier access to side-by-side cooling cores with enlarged access panels and doors
- 2. Air conditioning condenser swings open for improved access to radiator for cleaning





## Centralized ground-level access with filters relocated to a common area

Perform maintenance easily and quickly with a layout that centralizes fuel/oil filters at optimal height for easy access, promoting reduced labor during periodic inspections.

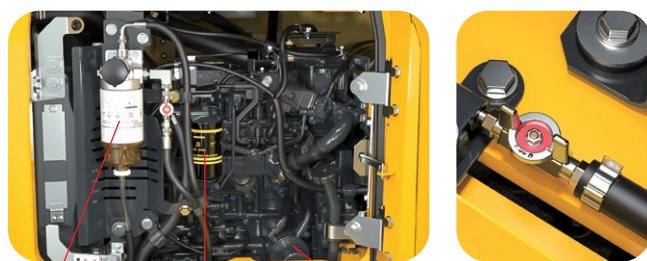

Fuel pre-filter (with water separator) High efficiency fuel filter

Fuel drain valve

## Engine oil drain valve

An easy-to-access engine oil drain valve helps simplify maintenance and makes it easier to collect used oil.

## Improved fueling access

Improved right-hand locking fuel tank cover provides easier ground-level access to fuel tank filler port and makes it easier to collect used oil.



The auxiliary hydraulic circuit return filter has been relocated for easier ground-level access alongside the windshield washer tank.



Washer tank Auxiliary hydraulic circuit return filter

## Easy-to-clean floor mat

The custom fit molded floor mat is easy to remove for cleaning.



## Optimize engine performance

The closed-circuit cooling system works to ensure that the machine operates within safe temperatures and requires minimal maintenance.

## Fan belt auto-tensioner

Low-maintenance fan belt auto-tensioner.

## Battery disconnect switch

A standard battery disconnect switch allows a technician to disconnect the power supply and lock out before servicing the machine.



## Long-life oil filter

Engine oil and engine oil filter	every 500 hours
Hydraulic oil	every 5000 hours
Hydraulic oil filter	every 1000 hours



Hydraulic oil filter

## Proactively schedule maintenance

Keep track and stay informed with the maintenance time monitor. Adjust the setting for a convenient service reminder (between 10 and 200 hours), or press the F6 key to see when maintenance is due next.

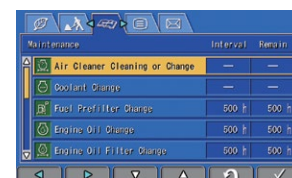

Maintenance screen

# Operation features

## True tight tail swing for confined areas

### Short implement swing radius — 12'2" (3,710 mm)

The boom raising angle of the PC78US-11 is larger than a conventional profile excavator, reducing the front implement swing radius.

### Tight tail swing radius — 4'7" (1,390 mm)

The short tail swing radius of the PC78US-11 allows the machine to work in more confined areas than a conventional machine.

### Round profile of front and rear portion of the upper structure

The design of the Komatsu tight tail hydraulic excavators allows the machine to work in surprisingly tight quarters.

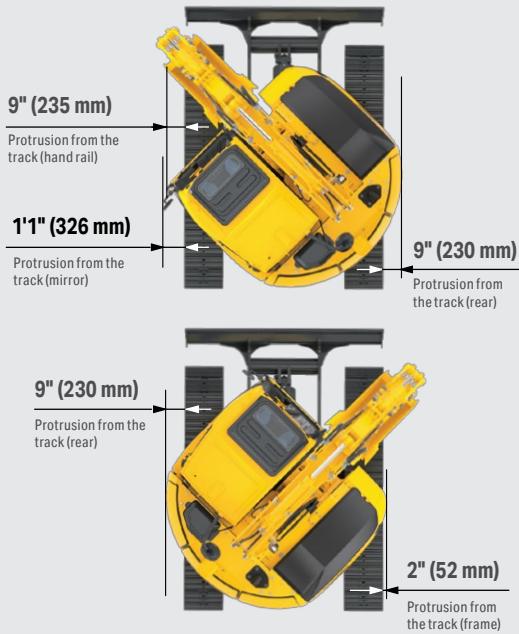
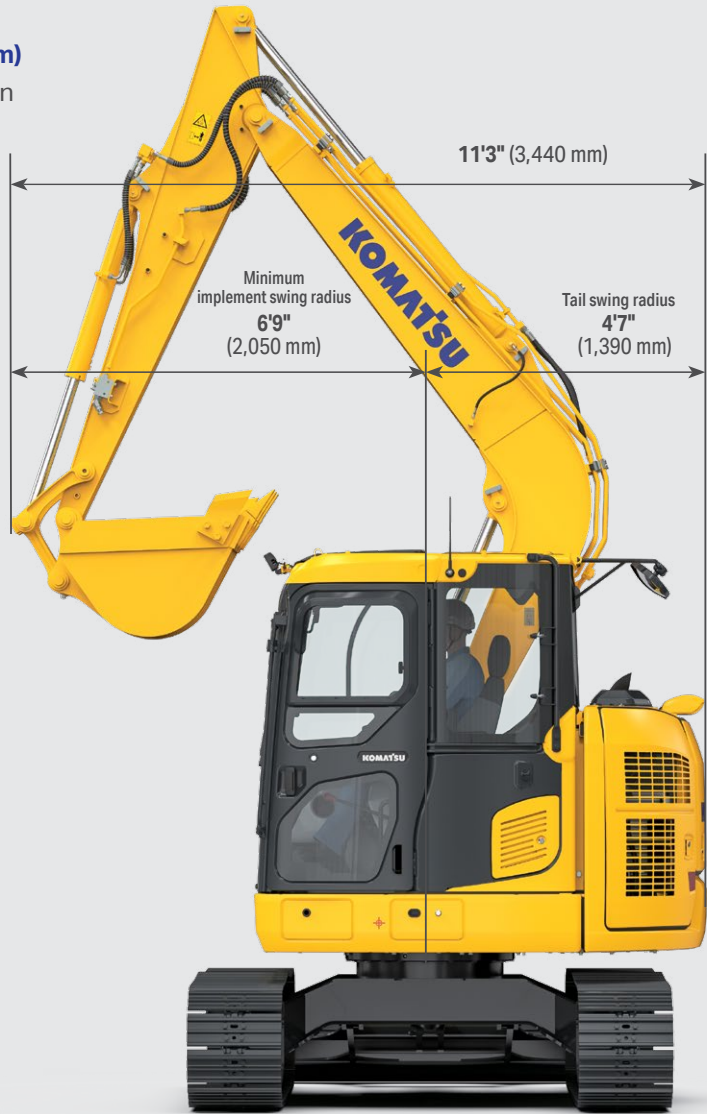

## Right side visibility

Redesigned right front compartment hood provides improved operator visibility.



### Operator and maintenance safety

When the lock lever is placed into lock position, the travel, swing, boom, arm, bucket and blade functions are all deactivated.



Lever shown in lock position

### Effective protection for operators

The machine features a ROPS cab that conforms to ISO 12117-2 for excavators as standard equipment. The ROPS cab has high shock absorption performance, and excellent durability and impact strength. It also satisfies the requirements of ISO OPG top guard level 1 for falling objects. The cab also features a retractable seat belt.



### Rearview monitoring system

The operator can view the rear of the machine with a color monitor screen.



Rear view image on monitor

### Switch between functions efficiently

A pattern change valve is standard and conveniently located below the cab, making switching from excavator to backhoe joystick control pattern quick and easy.

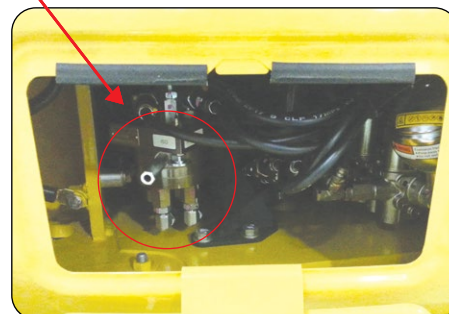

# Working environment

## Stay comfortable and connected while operating

The comfortable, pressurized cab is spacious with a low interior noise level at 71 dB (A) to enable longer operations with less operator fatigue. It also includes a reclining suspension seat with deep side supports and backrest angles that can be adjusted using a pull-up lever for optimal operating posture. Stay connected with a multifunction AM/FM radio, USB and Bluetooth wireless technology.



Suspension seat

Noise level at operator ears

**71** dbA



Multifunction stereo

## Automatic air conditioner

Easily and precisely set the cab atmosphere using the large LCD color monitor panel. The bi-level control function improves air flow and keeps the inside of the cab comfortable throughout the year.



## Designed to reduce vibration

Low vibration with viscous cab mounts incorporate a longer stroke and the addition of a spring. The cab damper mounting combined with a high-rigidity deck helps reduce vibration at the operator's seat.

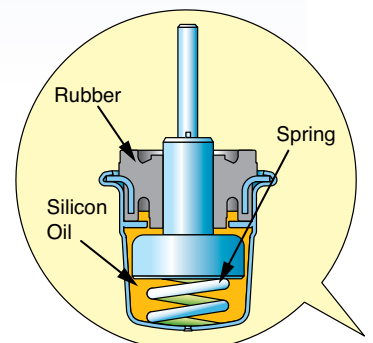

## Large high-resolution liquid crystal display (LCD) monitor



### Make informed decisions with machine monitor interface

The interface has been redesigned to enable the necessary information to be read and understood more easily, while retaining the maneuverability of previous models. A rearview camera image has been added to the default main screen. The interface has a function that enables the main screen to be switched, thus enabling the most useful screen for the particular work situation to be displayed.

#### Indicators

- |                                    |                                   |
|------------------------------------|-----------------------------------|
| 1 Auto-decelerator                 | 7 Hydraulic oil temperature gauge |
| 2 Working mode                     | 8 Fuel gauge                      |
| 3 Travel speed                     | 9 Service meter, clock            |
| 4 Ecology gauge                    | 10 Fuel consumption gauge         |
| 5 Camera display                   | 11 Guidance icon                  |
| 6 Engine coolant temperature gauge | 12 Function switches              |

#### Basic operation switches

- |                         |                 |
|-------------------------|-----------------|
| 1 Auto-decelerator      | 4 Buzzer cancel |
| 2 Working mode selector | 5 Wiper         |
| 3 Traveling selector    | 6 Window washer |

### Work efficiently with guidance and gauges

During operation, operators can refer to the ecology guidance screen for real-time notification of the machine's status. The monitor also has an ecology gauge and a fuel consumption gauge that allows operators to set any desired target value of fuel consumption to promote better fuel economy. Check operation records, fuel consumption history and ecology guidance records with a single touch.

- Avoid excessive engine idling
- Use "economy" mode to save fuel
- Avoid hydraulic relief pressure
- Reduce engine speed during long travel to help save fuel

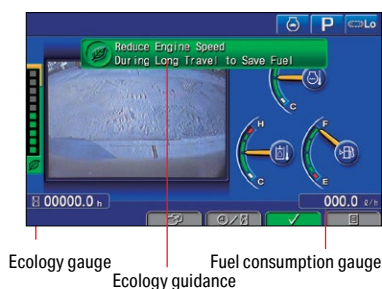

### Visual user menu

Pressing the F6 key on the main screen displays the user menu screen. The menus are grouped for each function and have easy-to-understand icons to help make operating the machine easier.

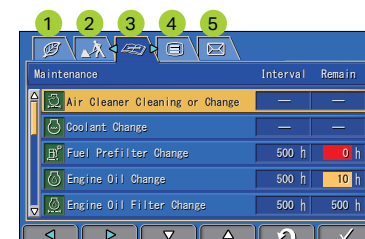

- 1 Energy saving guidance
- 2 Machine settings
- 3 Maintenance
- 4 Monitor setting
- 5 Mail check



Operation record



Fuel consumption history



Ecology guidance record

# Komatsu helps you bring it all together

## Get the most out of your fleet with My Komatsu

We've designed a portal that makes it easy to collect, visualize and monitor data for both Komatsu machines and other OEM machines. My Komatsu also gives you one easy source for accessing manuals and purchasing parts for your machines.

- Quickly collect, view and manage intuitive data displays in one location
- Help keep costs under control
- Benchmark machine performance and track fuel consumption
- Monitor for theft and unauthorized use
- Receive timely maintenance alerts

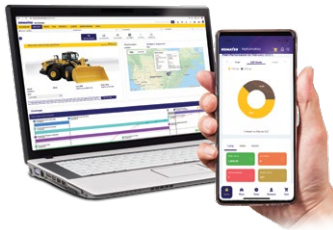

My Komatsu, our comprehensive portal, analyzes telematics data from your on-machine technology — Komtrax and Komtrax Plus, or from other OEMs — and displays it on easy-to-read dashboards. Now you can get the powerful analytics you need to manage your costs and enhance your fleet's efficiency without a complicated process or expensive third-party solutions.



**Data**  
Telematics data is generated by on-machine technology.



**Storage**  
Telematics data flows into data storage. ISO 15143-3 (AEMP 2.0) facilitates the extraction and raw data to your choice of databases.



**Connection**  
Choose how you want to connect and view your data. Go to multiple systems, send to a third party, or easily connect it all through My Komatsu.



**Analytics**  
My Komatsu connects telematics data from Komatsu and non-Komatsu equipment and creates powerful analytics dashboard views.

[mykomatsu.komatsu](http://mykomatsu.komatsu)

## Connect your machines to Smart Construction to optimize your job sites

Your projects depend on robust data that is easily shared, replicated, updated and — most important of all — correct.



Take a step toward a digital transformation of your job sites with Komatsu's suite of Smart Construction solutions, where advanced automation and integrated technologies intersect to help you:

- Track costs of labor, machines and materials
- Receive real-time insights straight from the field
- Enhance workflow with fully integrated data
- Visualize your data for actionable results
- Quickly map your job site
- Attract and retain talent



Not sure where to begin? Komatsu-certified solution experts are available on the phone, online or at your job site to help you navigate and thrive along your digitalization journey.

[komatsu.com/smart-construction](http://komatsu.com/smart-construction)

## Komatsu maintenance and repair programs

Simplify the complexities of machine owning and operating costs and enhance the value of your equipment with Komatsu's tiered maintenance and repair offerings. Manage your active coverage programs through the My Komatsu customer interface and take advantage of attractive financing options.

- Solutions that fit your needs and ease your mind
- Fixed maintenance and repair costs for the life of the contract
- National coverage



### Komatsu Care Complimentary

*Complimentary maintenance*

Our complimentary scheduled maintenance program for the first three years or 2,000 hours, whichever occurs first.

### Komatsu Care Plus

*Extended maintenance*

A continuation of the Komatsu Care program. Along with regularly scheduled maintenance and national distributor coverage, you get a variety of added benefits.

### Komatsu Care Plus II

*Extended maintenance and repair*

Everything in the Komatsu Care Plus program bundled with comprehensive repair coverage for qualifying repairs.

### Komatsu Care Plus III

*Extended maintenance, repair and consumables*

A comprehensive program that simplifies your equipment's total cost of ownership with a fixed cost per hour for qualifying repairs and replacements.

### Komatsu Care Advantage Warranty

*Extended warranty*

Protect your equipment in the event a covered component fails due to a defect in material or workmanship. Repairs are performed by Komatsu-trained experts using Komatsu genuine parts.

[komatsu.com/maintenance-repair](http://komatsu.com/maintenance-repair)

## Komatsu Financial

Financial services built for your business success.

[komatsu.com/financing](http://komatsu.com/financing)

## Komatsu Genuine Parts

Engineered to help extend the life of your Komatsu machine. Now available on the My Komatsu parts store.

[komatsu.com/parts](http://komatsu.com/parts)

## Komatsu training

Comprehensive training support — virtually, at our facility or where most convenient.

[komatsu.com/training](http://komatsu.com/training)



# Specifications

## Engine

Model	Komatsu SAA3D95E-1*	
Type	Water-cooled, 4-cycle, direct injection	
Aspiration	Turbocharged, aftercooled, cooled EGR	
Number of cylinders	3	
Bore	3.74"	95 mm
Stroke	4.53"	115 mm
Piston displacement	149.5 in <sup>3</sup>	2.45 L
Horsepower		
SAE J1995 (gross)	68 HP	50.7 kW
ISO 9249/SAE J1349 (net)	67.9 HP	50.6 kW
Rated rpm	1,850 rpm	
Fan drive method for radiator cooling	Mechanical with viscous fan clutch	
Governor	All-speed control, electronic	

\*U.S. EPA Tier 4 Final emission certified

## Hydraulics

Type: HydrauMind (Hydraulic mechanical intelligence system), closed-center system with load sensing valves and pressure compensated valves

Number of selectable working modes	6	
Main pumps		
Type	Variable displacement, axial position	
Pumps for	Boom, arm, bucket, swing and travel circuits	
Maximum flow	44.4 gpm	168 L/min
Type	Fixed displacement gear	
Pumps for	Blade	
Maximum flow	17 gpm	63 L/min
Hydraulic motors		
Travel	2 x piston motors with parking brake	
Swing	1 x axial piston motor with swing holding brake	
Relief valve setting		
Implement circuits	29.4 MPa	4,264 psi 300 kg/cm <sup>2</sup>
Travel circuits	29.9 MPa	4,337 psi 305 kg/cm <sup>2</sup>
Swing circuits	21.9 MPa	3,176 psi 223 kg/cm <sup>2</sup>
Pilot circuits	3.2 MPa	464 psi 33 kg/cm <sup>2</sup>
Blade circuits (raise)	12.3 MPa	1,784 psi 125 kg/cm <sup>2</sup>
Blade circuits (lower)	21.1 MPa	3,060 psi 215 kg/cm <sup>2</sup>

Hydraulic cylinders (bore x stroke x rod diameter)

Boom (1)	4.33" x 33.8" x 2.56"	110 mm x 858 mm x 65 mm
Arm (1)	3.74" x 33.9" x 2.36"	95 mm x 861 mm x 60 mm
Bucket (1)	3.35" x 27.95" x 2.17"	85 mm x 710 mm x 55 mm
Blade (1)	5.12" x 5.12" x 2.56"	130 mm x 130 mm x 65 mm
Auxiliary hydraulics		
Two-way	36.5 gpm	138 L/min
Relief	26.41 MPa	3,830 psi 270 kg/cm
One-way	21.1 gpm	80 L/min
Relief in breaker mode	17.17 MPa	2,490 psi 180 kg/cm

## Drives and brakes

Steering control	Two levers with pedals	
Drive method	Hydrostatic	
Maximum drawbar pull	68.1 kN	15,309 lbf 6,950 kgf
Maximum travel speed		
High	3.1 mph	5.0 km/h
Low	1.9 mph	2.7 km/h
Service brake	Hydraulic lock	
Parking brake	Mechanical disc	

## Swing system

Drive method	Hydraulic motor	
Swing reduction	Planetary gear	
Swing circle lubrication	Grease-bathed	
Swing lock	Mechanical disc brake	
Swing speed	10 rpm	

## Undercarriage

Center frame	X-frame leg	
Track frame	Box-section	
Track type	Sealed	
Track adjuster	Hydraulic	
Number of shoes (each side)	39	
Number of carrier rollers (each side)	1	
Number of track rollers (each side)	5	

## Coolant (refilling) and lubricant capacity

Fuel tank	33 gal	125 L
Radiator	4.8 gal	18 L
Engine	2.8 gal	10.5 L
Final drive (each side)	.29 gal	1.1 L
Swing drive	.53 gal	2.0 L
Hydraulic tank	14.8 gal	56 L

## Operating weight (approximate)

Includes:  
 One-piece boom 12'2" (3,710 mm)  
 Processor arm 7'5" (2,250 mm)  
 ISO 7451 heaped bucket .26 yd<sup>3</sup> (0.20 m<sup>3</sup>)  
 Blade  
 Rated capacity of lubricants  
 Coolant  
 Full fuel tank  
 Operator and standard equipment

Track shoes	Operating weight	Ground Pressure (ISO 16754)
Road liner 18" 450 mm	17,791 lbs. 8,070 kg	35.8 kPa 5.19 psi .36 kg/cm <sup>2</sup>
Triple grouser 18" 450 mm	17,483 lbs. 7,930 kg	35.8 kPa 5.19 psi .36 kg/cm <sup>2</sup>
Triple grouser 24" 600 mm	18,188 lbs. 8,250 kg	26.8 kPa 3.89 psi .27 kg/cm <sup>2</sup>
Rubber track 18" 450 mm	17,439 lbs. 7,910 kg	35.0 kPa 5.08 psi .35 kg/cm <sup>2</sup>

## Working forces

Arm length 7'5" (2,250 mm)			
ISO rating			
Bucket digging force	13,781 lbs.	61.3 kN	6,250 kgf
Arm crowd force	7,756 lbs.	34.5 kN	3,518 kgf
SAE rating			
Bucket digging force	11,668 lbs.	51.9 kN	5,300 kgf
Arm crowd force	7,373 lbs.	32.8 kN	3,350 kgf



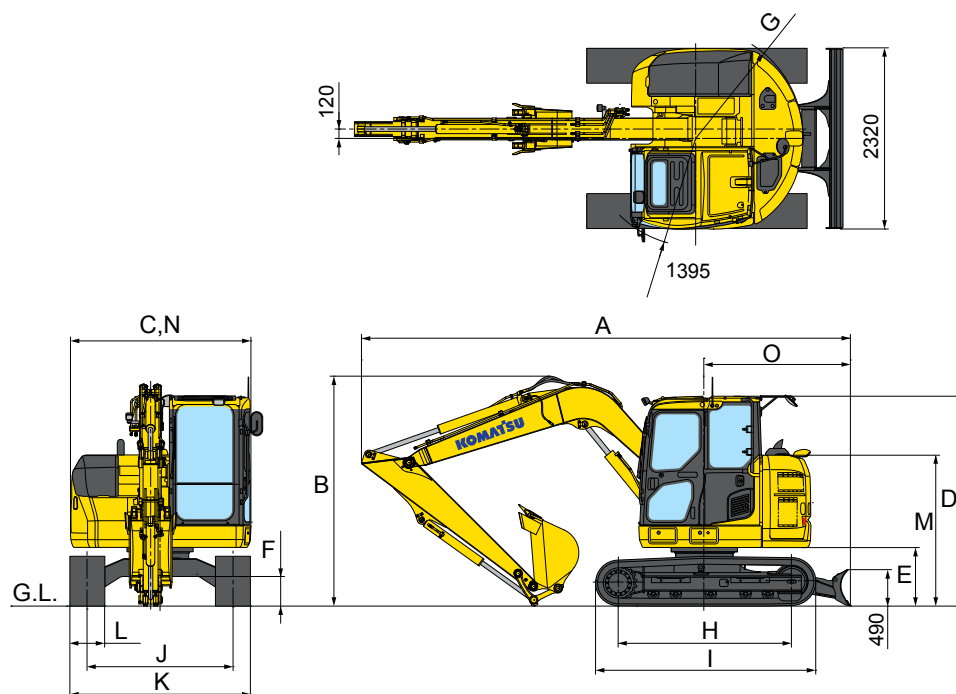

## Dimensions

Boom length	12'2" (3,710 mm)
Arm length	7'5" (2,250 mm)
A Overall length	20'8" (6,295 mm)
B Overall height (to top of boom)	9'8" (2,940 mm)
C Overall width	7'8" (2,330 mm)
D Overall height (to top of cab)*	9' (2,740 mm)
E Ground clearance, counterweight	2'7" (785 mm)
F Ground clearance, minimum	1'4" (410 mm)
G Tail swing radius	4'7" (1,390 mm)
H Track length on ground	7'4" (2,235 mm)
I Track length	9'6" (2,890 mm)
J Track gauge	6'2" (1,870 mm)
K Width of crawler	7'7" (2,320 mm)
L Shoe width	1'6" (450 mm)
M Machine engine hood height	6'9" (2,060 mm)
N Machine cab width	7'8" (2,330 mm)
O Distance, swing center to rear end	6'2" (1,885 mm)

\*Dimension of the machine with the road liner shoes

## Backhoe bucket, arm and boom combinations

Bucket Capacity (heaped)		Width		Weight	Number of Teeth	Arm Length 7'5" (2,250 mm)
SAE, PCSA	CECE	Without Cutters	With Cutters			
0.12 yd <sup>3</sup> (0.09 m <sup>3</sup> )	0.10 yd <sup>3</sup> (0.08 m <sup>3</sup> )	13.8" (350 mm)	17.7" (450 mm)	319.7 lb (145 kg)	3	0
0.16 yd <sup>3</sup> (0.12 m <sup>3</sup> )	0.14 yd <sup>3</sup> (0.11 m <sup>3</sup> )	17.7" (450 mm)	21.7" (550 mm)	352.7 lb (160 kg)	3	0
0.26 yd <sup>3</sup> (0.20 m <sup>3</sup> )	0.24 yd <sup>3</sup> (0.18 m <sup>3</sup> )	21.7" (550 mm)	25.6" (650 mm)	407.9 lb (185 kg)	3	0

# Specifications

## Working range

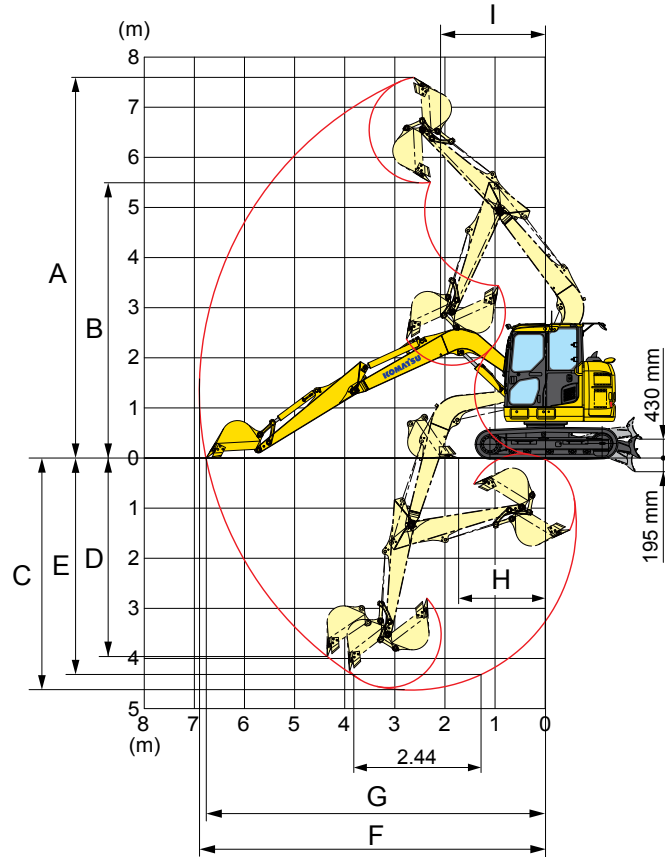

Boom Length	12'2" (3,710 mm)
Arm Length	7'5" (2,250 mm)
A Max. digging height	25'1" (7,650 mm)
B Max. dumping height	18'3" (5,550 mm)
C Max. digging depth	15'3" (4,660 mm)
D Max. vertical wall digging depth	13'1" (3,980 mm)
E Max. digging depth of cut for 8' (2,500 mm) level bottom	14'4" (4,380 mm)
F Max. digging reach	22'8" (6,920 mm)
G Max. digging reach at ground level	22'3" (6,780 mm)
H Min. digging reach at ground level	5'7" (1,710 mm)
I Min. swing radius	6'9" (2,050 mm)
SAE rating	
Bucket digging force	53.3 kN 11,982 lb (5,440 kg)
Arm crowd force	33.3 kN 7,486 lb (6,250 kgf)
ISO rating	
Bucket digging force	61.3 kN 13,780 lb (6,520 kg)
Arm crowd force	34.5 kN 7,756 lb (3,520 kgf)

With road liner

## Lifting capacity with lifting mode

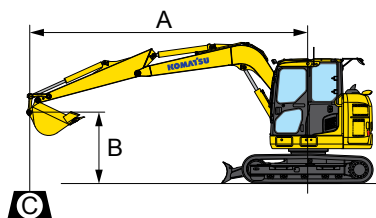

- A: Reach from swing center
- B: Bucket hook height
- C: Lifting capacity
- Cf: Rating over front
- Cs: Rating over side
- ⊗: Rating at maximum reach

Arm: 7'5" (2,250mm)      Bucketless (without cylinder and links)      Shoe width: 450 mm Road Liner      Blade on ground

B \ A	4'11" (1.5 m)		6'7" (2.0 m)		10'0" (3.0 m)		13'1" (4.0 m)		16'5" (5.0 m)		⊗ MAX		
	Cf	Cs	Cf	Cs	Cf	Cs	Cf	Cs	Cf	Cs	Cf	Cs	
19.7 ft (6m)	lb (kg)										* 3,770 (1,710)	* 3,770 (1,710)	
16.4 ft (5m)	lb (kg)						* 3,740 (1,690)	* 3,360 (1,520)			* 3,360 (1,520)	* 3,360 (1,520)	
13.1 ft (4m)	lb (kg)						* 3,780 (1,710)	* 2,830 (1,280)	* 3,760 (1,700)	3,160 (1,430)	* 3,220 (1,460)	2,830 (1,280)	
9.8 ft (3m)	lb (kg)				* 4,690 (2,120)	* 4,690 (2,120)	* 4,200 (1,900)	* 2,280 (1,030)	* 3,900 (1,760)	3,120 (1,410)	* 3,210 (1,450)	2,280 (1,030)	
6.6 ft (2m)	lb (kg)				* 6,110 (2,770)	* 6,110 (2,770)	* 4,180 (1,890)	4,050 (1,830)	* 4,190 (1,900)	3,040 (1,370)	* 3,310 (1,500)	2,500 (1,130)	
3.3 ft (1m)	lb (kg)				* 7,420 (3,360)	6,050 (2,740)	* 4,000 (1,810)	3,800 (1,720)	* 4,490 (2,040)	2,940 (1,330)	* 3,530 (1,600)	2,330 (1,060)	
GL	lb (kg)				* 7,970 (3,610)	5,770 (2,620)	* 3,860 (1,750)	3,620 (1,640)	* 4,670 (2,110)	2,860 (1,290)	* 3,900 (1,770)	2,310 (1,040)	
-3.3 ft (-1m)	lb (kg)	* 5,330 (2,410)	* 5,330 (2,410)	* 7,850 (3,560)	* 7,850 (3,560)	* 7,890 (3,580)	5,630 (2,550)	* 3,770 (1,710)	3,540 (1,600)	* 4,580 (2,070)	2,810 (1,270)	* 3,970 (1,800)	2,460 (1,110)
-6.6 ft (-2m)	lb (kg)	* 9,920 (4,500)	* 9,920 (4,500)	* 10,150 (4,600)	* 10,150 (4,600)	* 7,260 (3,290)	5,620 (2,460)	* 3,750 (1,700)	3,540 (1,600)	* 3,990 (1,800)	2,810 (1,270)	* 3,970 (1,800)	2,800 (1,270)

Arm: 7'5" (2,250mm)      Bucketless (without cylinder and links)      Shoe width: 450 mm Road Liner      Blade on ground

B \ A	4'11" (1.5 m)		6'7" (2.0 m)		10'0" (3.0 m)		13'1" (4.0 m)		16'5" (5.0 m)		⊗ MAX		
	Cf	Cs	Cf	Cs	Cf	Cs	Cf	Cs	Cf	Cs	Cf	Cs	
19.7 ft (6m)	lb (kg)										* 3,770 (1,710)	* 3,770 (1,710)	
16.4 ft (5m)	lb (kg)						* 3,740 (1,690)	* 3,740 (1,690)			* 3,360 (1,520)	* 3,360 (1,520)	
13.1 ft (4m)	lb (kg)						* 3,780 (1,710)	* 3,780 (1,710)	3,700 (1,680)	3,160 (1,430)	* 3,220 (1,460)	2,830 (1,280)	
9.8 ft (3m)	lb (kg)				* 4,690 (2,120)	* 4,690 (2,120)	* 4,200 (1,900)	* 4,200 (1,900)	3,660 (1,660)	3,120 (1,410)	2,930 (1,320)	2,280 (1,030)	
6.6 ft (2m)	lb (kg)				* 6,110 (2,770)	* 6,110 (2,770)	* 4,850 (2,200)	4,180 (1,890)	3,570 (1,620)	3,040 (1,370)	2,730 (1,240)	2,500 (1,130)	
3.3 ft (1m)	lb (kg)				7,390 (3,350)	6,050 (2,740)	4,790 (2,170)	4,000 (1,810)	3,470 (1,570)	2,940 (1,330)	2,670 (1,210)	2,330 (1,060)	
GL	lb (kg)				7,150 (3,240)	5,770 (2,620)	4,630 (2,100)	3,860 (1,750)	3,380 (1,530)	2,860 (1,290)	2,710 (1,230)	2,310 (1,040)	
-3.3 ft (-1m)	lb (kg)	* 5,330 (2,410)	* 5,330 (2,410)	* 7,850 (3,560)	* 7,850 (3,560)	7,000 (3,170)	5,630 (2,550)	4,530 (2,050)	3,770 (1,710)	3,330 (1,510)	2,810 (1,270)	2,900 (1,310)	2,460 (1,110)
-6.6 ft (-2m)	lb (kg)	* 9,920 (4,500)	* 9,920 (4,500)	* 10,150 (4,600)	* 10,150 (4,600)	6,960 (3,160)	5,620 (2,550)	4,510 (2,040)	3,750 (1,700)	3,330 (1,510)	2,810 (1,270)	3,330 (1,510)	2,800 (1,270)

\*Asterisk indicates load is limited by hydraulic capacity rather than tipping. Ratings are based on ISO standard No. 10567. Rated load capacity does not exceed 87% of hydraulic lift capacity or 75% of tipping load. Total weight of bucket and/or installed attachments must be deducted from the capacities shown above. Lift capacity chart is based on machine located on a solid, level and uniform surface. Load ratings are at the arm bucket pin location, use of any attachment point in a different location to handle objects could affect excavator lift performance.

# Specifications

## Lifting capacity with lifting mode

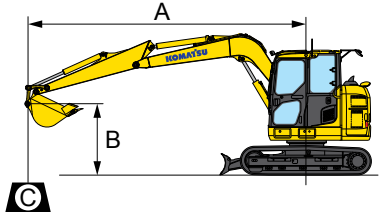

- A: Reach from swing center
- B: Bucket hook height
- C: Lifting capacity
- Cf: Rating over front
- Cs: Rating over side
- ⊗: Rating at maximum reach

Arm: 7'5" (2,250mm)      Bucketless (without cylinder and links)      Shoe width: 450 mm Road Liner      Blade on ground

A \ B		4'11" (1.5 m)		6'7" (2.0 m)		10'0" (3.0 m)		13'1" (4.0 m)		16'5" (5.0 m)		⊗ MAX	
		Cf	Cs	Cf	Cs	Cf	Cs	Cf	Cs	Cf	Cs	Cf	Cs
19.7 ft (6m)	lb (kg)											* 3,770 (1,710)	* 3,770 (1,710)
16.4 ft (5m)	lb (kg)							* 3,740 (1,690)	* 3,740 (1,690)			* 3,360 (1,520)	* 3,360 (1,520)
13.1 ft (4m)	lb (kg)							* 3,780 (1,710)	* 3,780 (1,710)	* 3,760 (1,700)	3,090 (1,400)	* 3,220 (1,460)	2,760 (1,250)
9.8 ft (3m)	lb (kg)					* 4,690 (2,120)	* 4,690 (2,120)	* 4,200 (1,900)	* 4,200 (1,900)	* 3,900 (1,760)	3,040 (1,380)	* 3,210 (1,450)	2,440 (1,100)
6.6 ft (2m)	lb (kg)					* 6,110 (2,770)	* 6,110 (2,770)	* 4,850 (2,200)	4,080 (1,850)	* 4,190 (1,900)	2,960 (1,340)	* 3,310 (1,500)	2,270 (1,030)
3.3 ft (1m)	lb (kg)					* 7,420 (3,360)	5,890 (2,670)	* 5,490 (2,490)	3,900 (1,770)	* 4,490 (2,040)	2,860 (1,300)	* 3,530 (1,600)	2,210 (1,000)
GL	lb (kg)					* 7,970 (3,610)	5,620 (2,550)	* 5,860 (2,660)	3,760 (1,700)	* 4,670 (2,110)	2,780 (1,260)	* 3,900 (1,770)	2,240 (1,020)
-3.3 ft (-1m)	lb (kg)	* 5,330 (2,410)	* 5,330 (2,410)	* 7,850 (3,560)	* 7,850 (3,560)	* 7,890 (3,580)	5,480 (2,480)	* 5,860 (2,660)	3,660 (1,660)	* 4,580 (2,070)	2,730 (1,240)	* 3,970 (1,800)	2,390 (1,080)
-6.6 ft (-2m)	lb (kg)	* 9,920 (4,500)	* 9,920 (4,500)	* 10,150 (4,600)	* 10,150 (4,600)	* 7,260 (3,290)	5,470 (2,480)	* 5,440 (2,460)	3,640 (1,650)	* 3,990 (1,810)	2,730 (1,230)	* 3,970 (1,800)	2,730 (1,230)

Arm: 7'5" (2,250mm)      Bucketless (without cylinder and links)      Shoe width: 450 mm Road Liner      Blade on ground

A \ B		4'11" (1.5 m)		6'7" (2.0 m)		10'0" (3.0 m)		13'1" (4.0 m)		16'5" (5.0 m)		⊗ MAX	
		Cf	Cs	Cf	Cs	Cf	Cs	Cf	Cs	Cf	Cs	Cf	Cs
19.7 ft (6m)	lb (kg)											* 3,770 (1,710)	* 3,770 (1,710)
16.4 ft (5m)	lb (kg)							* 3,740 (1,690)	* 3,740 (1,690)			* 3,360 (1,520)	* 3,360 (1,520)
13.1 ft (4m)	lb (kg)							* 3,780 (1,710)	* 3,780 (1,710)	3,600 (1,630)	3,090 (1,400)	* 3,220 (1,460)	2,760 (1,250)
9.8 ft (3m)	lb (kg)					* 4,690 (2,120)	* 4,690 (2,120)	* 4,200 (1,900)	* 4,200 (1,900)	3,560 (1,610)	3,040 (1,380)	2,850 (1,290)	2,440 (1,100)
6.6 ft (2m)	lb (kg)					* 6,110 (2,770)	* 6,110 (2,770)	* 4,850 (2,200)	4,080 (1,850)	3,470 (1,570)	2,960 (1,340)	2,660 (1,200)	2,270 (1,030)
3.3 ft (1m)	lb (kg)					7,190 (3,260)	5,890 (2,670)	4,660 (2,110)	3,900 (1,770)	3,370 (1,530)	2,860 (1,300)	2,590 (1,170)	2,210 (1,000)
GL	lb (kg)					6,950 (3,150)	5,620 (2,550)	4,500 (2,040)	3,760 (1,700)	3,280 (1,490)	2,780 (1,260)	2,630 (1,190)	2,240 (1,020)
-3.3 ft (-1m)	lb (kg)	* 5,330 (2,410)	* 5,330 (2,410)	* 7,850 (3,560)	* 7,850 (3,560)	6,800 (3,080)	5,480 (2,480)	4,400 (1,990)	3,660 (1,660)	3,230 (1,460)	2,730 (1,240)	2,820 (1,270)	2,390 (1,080)
-6.6 ft (-2m)	lb (kg)	* 9,920 (4,500)	* 9,920 (4,500)	* 10,150 (4,600)	* 10,150 (4,600)	6,790 (3,080)	5,470 (2,480)	4,380 (1,980)	3,640 (1,650)	3,230 (1,460)	2,730 (1,230)	3,230 (1,460)	2,730 (1,230)

\*Asterisk indicates load is limited by hydraulic capacity rather than tipping. Ratings are based on ISO standard No. 10567. Rated load capacity does not exceed 87% of hydraulic lift capacity or 75% of tipping load. Total weight of bucket and/or installed attachments must be deducted from the capacities shown above. Lift capacity chart is based on machine located on a solid, level and uniform surface. Load ratings are at the arm bucket pin location, use of any attachment point in a different location to handle objects could affect excavator lift performance.

## Lifting capacity with lifting mode

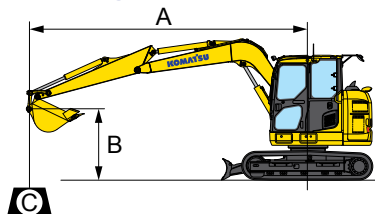

- A: Reach from swing center
- B: Bucket hook height
- C: Lifting capacity
- Cf: Rating over front
- Cs: Rating over side
- ☉: Rating at maximum reach

Arm: 7'5" (2,250mm)      Bucketless (without cylinder and links)      Shoe width: 450 mm Road Liner      Blade on ground

B \ A		4'11" (1.5 m)		6'7" (2.0 m)		10'0" (3.0 m)		13'1" (4.0 m)		16'5" (5.0 m)		☉ MAX	
		Cf	Cs	Cf	Cs	Cf	Cs	Cf	Cs	Cf	Cs	Cf	Cs
19.7 ft (6m)	lb (kg)											* 3,770 (1,710)	* 3,770 (1,710)
16.4 ft (5m)	lb (kg)							* 3,740 (1,690)	* 3,740 (1,690)			* 3,360 (1,520)	* 3,360 (1,520)
13.1 ft (4m)	lb (kg)							* 3,780 (1,710)	* 3,780 (1,710)	* 3,760 (1,700)	3,110 (1,410)	* 3,220 (1,460)	2,780 (1,260)
9.8 ft (3m)	lb (kg)					* 4,690 (2,120)	* 4,690 (2,120)	* 4,200 (1,900)	* 4,200 (1,900)	* 3,900 (1,760)	3,070 (1,390)	* 3,210 (1,450)	2,460 (1,110)
6.6 ft (2m)	lb (kg)					* 6,110 (2,770)	* 6,110 (2,770)	* 4,850 (2,200)	4,110 (1,860)	* 4,190 (1,900)	2,980 (1,350)	* 3,310 (1,500)	2,290 (1,040)
3.3 ft (1m)	lb (kg)					* 7,420 (3,360)	5,940 (2,690)	* 5,490 (2,490)	3,930 (1,780)	* 4,490 (2,040)	2,890 (1,310)	* 3,530 (1,600)	2,230 (1,010)
GL	lb (kg)					* 7,970 (3,610)	5,670 (2,570)	* 5,860 (2,660)	3,790 (1,720)	* 4,670 (2,110)	2,800 (1,270)	* 3,900 (1,770)	2,260 (1,020)
-3.3 ft (-1m)	lb (kg)	* 5,330 (2,410)	* 5,330 (2,410)	* 7,850 (3,560)	* 7,850 (3,560)	* 7,890 (3,580)	5,530 (2,510)	* 5,860 (2,660)	3,700 (1,670)	* 4,580 (2,070)	2,750 (1,250)	* 3,970 (1,800)	2,410 (1,090)
-6.6 ft (-2m)	lb (kg)	* 9,920 (4,500)	* 9,920 (4,500)	* 10,150 (4,600)	* 10,150 (4,600)	* 7,260 (3,290)	5,520 (2,500)	* 5,440 (2,460)	3,680 (1,660)	* 3,990 (1,810)	2,750 (1,250)	* 3,970 (1,800)	2,750 (1,250)

Arm: 7'5" (2,250mm)      Bucketless (without cylinder and links)      Shoe width: 450 mm Road Liner      Blade on ground

B \ A		4'11" (1.5 m)		6'7" (2.0 m)		10'0" (3.0 m)		13'1" (4.0 m)		16'5" (5.0 m)		☉ MAX	
		Cf	Cs	Cf	Cs	Cf	Cs	Cf	Cs	Cf	Cs	Cf	Cs
19.7 ft (6m)	lb (kg)											* 3,770 (1,710)	* 3,770 (1,710)
16.4 ft (5m)	lb (kg)							* 3,740 (1,690)	* 3,740 (1,690)			* 3,360 (1,520)	* 3,360 (1,520)
13.1 ft (4m)	lb (kg)							* 3,780 (1,710)	* 3,780 (1,710)	3,630 (1,650)	3,110 (1,410)	* 3,220 (1,460)	2,780 (1,260)
9.8 ft (3m)	lb (kg)					* 4,690 (2,120)	* 4,690 (2,120)	* 4,200 (1,900)	* 4,200 (1,900)	3,590 (1,630)	3,070 (1,390)	2,870 (1,300)	2,460 (1,110)
6.6 ft (2m)	lb (kg)					* 6,110 (2,770)	* 6,110 (2,770)	* 4,850 (2,200)	4,110 (1,860)	3,500 (1,590)	2,980 (1,350)	2,680 (1,210)	2,290 (1,040)
3.3 ft (1m)	lb (kg)					7,250 (3,290)	5,940 (2,690)	4,700 (2,130)	3,930 (1,780)	3,400 (1,540)	2,890 (1,310)	2,610 (1,180)	2,230 (1,010)
GL	lb (kg)					7,010 (3,180)	5,670 (2,570)	4,540 (2,060)	3,790 (1,720)	3,310 (1,500)	2,800 (1,270)	2,660 (1,200)	2,260 (1,020)
-3.3 ft (-1m)	lb (kg)	* 5,330 (2,410)	* 5,330 (2,410)	* 7,850 (3,560)	* 7,850 (3,560)	6,860 (3,110)	5,530 (2,510)	4,440 (2,010)	3,700 (1,670)	3,260 (1,480)	2,750 (1,250)	2,840 (1,280)	2,410 (1,090)
-6.6 ft (-2m)	lb (kg)	* 9,920 (4,500)	* 9,920 (4,500)	* 10,150 (4,600)	* 10,150 (4,600)	6,850 (3,100)	5,520 (2,500)	4,420 (2,000)	3,680 (1,660)	3,260 (1,480)	2,750 (1,250)	3,260 (1,480)	2,750 (1,250)

\*Asterisk indicates load is limited by hydraulic capacity rather than tipping. Ratings are based on ISO standard No. 10567. Rated load capacity does not exceed 87% of hydraulic lift capacity or 75% of tipping load. Total weight of bucket and/or installed attachments must be deducted from the capacities shown above. Lift capacity chart is based on machine located on a solid, level and uniform surface. Load ratings are at the arm bucket pin location, use of any attachment point in a different location to handle objects could affect excavator lift performance.

# Specifications

## Lifting capacity with lifting mode

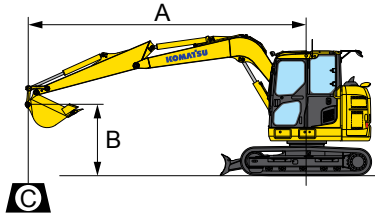

- A: Reach from swing center
- B: Bucket hook height
- C: Lifting capacity
- Cf: Rating over front
- Cs: Rating over side
- ☉: Rating at maximum reach

Arm: 7'5" (2,250mm)      Bucketless (without cylinder and links)      Shoe width: 450 mm Road Liner      Blade on ground

A \ B		4'11" (1.5 m)		6'7" (2.0 m)		10'0" (3.0 m)		13'1" (4.0 m)		16'5" (5.0 m)		☉ MAX	
		Cf	Cs	Cf	Cs	Cf	Cs	Cf	Cs	Cf	Cs	Cf	Cs
19.7 ft (6m)	lb (kg)											* 3,770 (1,710)	* 3,770 (1,710)
16.4 ft (5m)	lb (kg)							* 3,740 (1,690)	* 3,740 (1,690)			* 3,360 (1,520)	* 3,360 (1,520)
13.1 ft (4m)	lb (kg)							* 3,780 (1,710)	* 3,780 (1,710)	* 3,760 (1,700)	* 3,170 (1,440)	3,220 (1,460)	2,840 (1,280)
9.8 ft (3m)	lb (kg)					* 4,690 (2,120)	* 4,690 (2,120)	* 4,200 (1,900)	* 4,200 (1,900)	* 3,900 (1,760)	3,130 (1,420)	* 3,210 (1,450)	2,510 (1,140)
6.6 ft (2m)	lb (kg)					* 6,110 (2,770)	* 6,110 (2,770)	* 4,850 (2,200)	* 4,200 (1,900)	* 4,190 (1,900)	3,050 (1,380)	* 3,310 (1,500)	2,340 (1,060)
3.3 ft (1m)	lb (kg)					* 7,420 (3,360)	6,070 (2,750)	* 5,490 (2,490)	4,020 (1,820)	* 4,490 (2,040)	2,950 (1,340)	* 3,530 (1,600)	2,280 (1,030)
GL	lb (kg)					* 7,970 (3,610)	5,790 (2,630)	* 5,860 (2,660)	3,870 (1,750)	* 4,670 (2,110)	2,870 (1,300)	* 3,900 (1,770)	2,320 (1,050)
-3.3 ft (-1m)	lb (kg)	* 5,330 (2,410)	* 5,330 (2,410)	* 7,850 (3,560)	* 7,850 (3,560)	* 7,890 (3,580)	5,660 (2,560)	* 5,860 (2,660)	3,780 (1,710)	* 4,580 (2,070)	2,820 (1,280)	* 3,970 (1,800)	2,470 (1,120)
-6.6 ft (-2m)	lb (kg)	* 9,920 (4,500)	* 9,920 (4,500)	* 10,150 (4,600)	* 10,150 (4,600)	* 7,260 (3,290)	5,660 (2,560)	* 5,440 (2,460)	3,760 (1,700)	* 3,990 (1,810)	2,820 (1,270)	* 3,970 (1,800)	2,820 (1,270)

Arm: 7'5" (2,250mm)      Bucketless (without cylinder and links)      Shoe width: 450 mm Road Liner      Blade on ground

A \ B		4'11" (1.5 m)		6'7" (2.0 m)		10'0" (3.0 m)		13'1" (4.0 m)		16'5" (5.0 m)		☉ MAX	
		Cf	Cs	Cf	Cs	Cf	Cs	Cf	Cs	Cf	Cs	Cf	Cs
19.7 ft (6m)	lb (kg)											* 3,770 (1,710)	* 3,770 (1,710)
16.4 ft (5m)	lb (kg)							* 3,740 (1,690)	* 3,740 (1,690)			* 3,360 (1,520)	* 3,360 (1,520)
13.1 ft (4m)	lb (kg)							* 3,780 (1,710)	* 3,780 (1,710)	3,710 (1,680)	* 3,170 (1,440)	* 3,220 (1,460)	2,840 (1,280)
9.8 ft (3m)	lb (kg)					* 4,690 (2,120)	* 4,690 (2,120)	* 4,200 (1,900)	* 4,200 (1,900)	3,670 (1,660)	3,130 (1,420)	2,940 (1,330)	2,510 (1,140)
6.6 ft (2m)	lb (kg)					* 6,110 (2,770)	* 6,110 (2,770)	* 4,850 (2,200)	* 4,200 (1,900)	3,580 (1,620)	3,050 (1,380)	2,740 (1,240)	2,340 (1,060)
3.3 ft (1m)	lb (kg)					* 7,420 (3,360)	6,070 (2,750)	4,800 (2,180)	4,020 (1,820)	3,480 (1,580)	2,950 (1,340)	2,680 (1,210)	2,280 (1,030)
GL	lb (kg)					7,180 (3,250)	5,790 (2,630)	4,650 (2,110)	3,870 (1,750)	3,390 (1,540)	2,870 (1,300)	2,720 (1,230)	2,320 (1,050)
-3.3 ft (-1m)	lb (kg)	* 5,330 (2,410)	* 5,330 (2,410)	* 7,850 (3,560)	* 7,850 (3,560)	7,030 (3,190)	5,660 (2,560)	4,550 (2,060)	3,780 (1,710)	3,340 (1,510)	2,820 (1,280)	2,910 (1,320)	2,470 (1,120)
-6.6 ft (-2m)	lb (kg)	* 9,920 (4,500)	* 9,920 (4,500)	* 10,150 (4,600)	* 10,150 (4,600)	6,990 (3,170)	5,660 (2,560)	4,530 (2,050)	3,760 (1,700)	3,340 (1,510)	2,820 (1,270)	3,340 (1,510)	2,820 (1,270)

\*Asterisk indicates load is limited by hydraulic capacity rather than tipping. Ratings are based on ISO standard No. 10567. Rated load capacity does not exceed 87% of hydraulic lift capacity or 75% of tipping load. Total weight of bucket and/or installed attachments must be deducted from the capacities shown above. Lift capacity chart is based on machine located on a solid, level and uniform surface. Load ratings are at the arm bucket pin location, use of any attachment point in a different location to handle objects could affect excavator lift performance.

# Standard and optional equipment

## Engine and related components

Engine, Komatsu SAA3D95E-1	•
Auto deceleration	•
Air cleaner, double element with auto dust evacuator	•
B20 biodiesel compatible*	•
Cooling system viscous fan clutch, suction type	•
Cooling system with expansion tank	•
Engine oil-pan drain valve	•
Fixed turbocharger	•
Komatsu Diesel Oxidation Catalyst (KDOC)	•

## Electrical system

Alternator, 24V/60 A	•
Batteries, 2 x 12V/55 Ah	•
Battery disconnect switch	•
Lock out/tag out provisioned	•
Starting motor 24V/4.5 kW	•

## Guards and covers

Fan guard	•
Pump/engine partition cover	•
Diesel ground level fuel fill and hydraulic tank fill cap under lockable side covers	•
Bolt-on top guard (OPG level 2)	○
Cab front guard (full height front window mesh guard level 1)	○

## Operator environment

24V x 2 power supply	•
Attachment flow switching through monitor	•
Auto climate control	•
Auto idle shutdown	•
Cab includes: antenna, multifunction audio with USB and Bluetooth wireless technology, floormat, intermittent front windshield wiper and washer, large ceiling hatch, pull-up front window, removable lower windshield	•
Handrails	•
Komtrax 5.0 (cellular 4G system)	•
LED working light on boom	•
LED working light on cab	•
Lock lever auto lock function	•
Monitor panel	•
Operator identification system	•
Rearview mirrors (LH, rear)	•
Rearview monitoring system	•
ROPS cab (ISO 12117-2)	•
Seat belt, 3.1" (78 mm)	•
Suspension seat	•
Swing holding brake	•
Travel alarm	•
Travel switch on blade control lever (high/low)	•

## Hydraulic system

standard • optional ○

Dual stage relief valve	•
Proportional control on floor for auxiliary hydraulics	•
Hydraulic control unit (one additional actuator)	•
One-way/two-way auxiliary hydraulic flow	•
Operation pattern change-over valve (two-way, ISO/BH)	•
One-variable piston pump and one gear pump	•
Auxiliary circuit return filter and accumulator	•
Automatic swing brake	•
Automatic load sensing two speed travel	•

## Work equipment

Blade, welded cutting edge type 7'7" (2,330 mm)	•
Counterweight, 1,775 lbs. (805 kg)	•
Boom, one-piece, non-swing 12'2" (3,710 mm)	○
Arm, 7'5" (2,250 mm) arm assembly	○
Blade, 8' 1" (2,400 mm) wide blade, requires 24" (600 mm) shoes	○

## Undercarriage

Triple grouser shoe, 18" (450 mm)	•
Shoes	
Roadliner shoes, 18" (450 mm)	○
Triple grouser shoes, 24" (600 mm)	○
Rubber belt track, 18" (450 mm)	○

## Attachment options

Buckets	○
Couplers	○
Thumbs	○
Breakers	○

For a complete list of available attachments, please contact your local Komatsu distributor.

\*Up to 20% blended biodiesel fuel and paraffin fuel can be used. Please consult your Komatsu distributor for details.

---

Product designs, specifications and/or data in this document are provided for informational purposes only and are not warranties of any kind. Product designs and/or specifications may be changed at any time without notice. The only warranties that apply to sales of products and services are Komatsu's standard written warranties, which will be furnished upon request.

Komatsu and other trademarks and service marks used herein are the property of Komatsu Ltd. or its subsidiaries, or the respective owners or licensees.

**KOMATSU**

