

# KOMATSU



## Fully Automatic Symmetric Quick Coupler (SQ-V)



### Models/weights

SQ60V	17,640-39,688 lbs.	8-18 mt
SQ70V	33,070-61,730 lbs.	15-28 mt
SQ70-55V	39,685-70,550 lbs.	18-32 mt
SQ80V	55,115-94,800 lbs.	25-43 mt
SQ90V	88,185-154,325 lbs.	48-70 mt

# The Fully Automatic Symmetric Quick Coupler System by Lehnhoff

With the Lehnhoff Fully Automatic Symmetric Quick Coupler (SQ-V) system, you can change hydraulic attachments without leaving the cab of the excavator. The combination of a symmetrical quick coupler and Lehnhoff's integrated, patented valve technology delivers outstanding advantages:

- Potential to save in additional excavator and personnel cost
- Increased productivity with less time spent on manual attachment changes
- Easier attachment changes even with short working cycles
- Keeps operator comfortably out of harm's way
- Potential to expand your available range of services





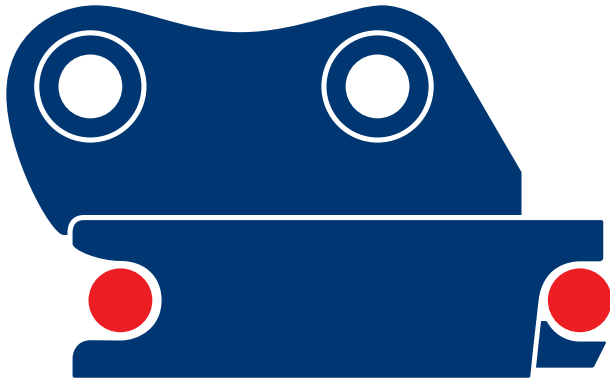

## Lehnhoff symmetrical quick coupler (SQ)

### One standard, many possibilities

SQ quick couplers are based on the S-standard and are compact, light and robust. The standardized interface with two coupling shafts enables rigid attachments such as buckets to be rotated by 180 degrees to use as a backhoe or shovel (S-standard interface provided).

### What is the S-standard?

- Open industry standard for the interface between excavator and attachment
- Ensures compatibility between different manufacturers for rigid attachments
- Symmetrically aligned pins on adapter plates — as indicated in red in the above graphic
- Size specification refers to shaft diameter  
SQ80 = shaft diameter 80 mm (3.2 in)

### S-Standard + \*

Lehnhoff SQ complements the symmetrical concept of the S-standard with an ingenious feature: a symmetrically constructed valve block that allows attachments such as a tilting bucket or a crusher bucket to be operated hydraulically in shovel mode. A built-in protection function prevents misdirected engagement with attachments that are not intended for reverse mode such as with a breaker.

### S-Standard+ advantages

- Compact, robust and light
- Preservation of the excavator's breakout force
- Well-suited to tiltrotator applications
- Protected hoses
- Reverse mode also for hydraulic attachments (if applicable)\*
- Adjusted to kinematic and performance level of the respective machine



\*S-Standard + not applicable to SQ90V models

# Lehnhoff Fully Automatic Symmetric Quick Coupler (SQ-V)

## Lehnhoff SQ-V: The technical highlights

- Precise hydraulic connection through patented valve technology
- The extremely short stroke of 0-.20" allows immediate full oil flow through mechanical activation
- Short stroke valves for high performance with minimum pressure loss and low heat generation
- Easy-to-maintain valve technology (quick and convenient on-site valve and/or seal changes)
- Fully symmetrical valve block arrangement enables 180-degree rotated application of hydraulic attachments such as tilt buckets, screen buckets and crusher buckets\*
- Reinforced S and A blocks provide protection of valves. Flat surfaces provide ease of access for maintenance
- Emergency unlocking

### Block Internal Depressurization (BID) unit

During the unlocking process, the high-flow (1st ATT) line and low-flow (2nd ATT) line in both S and A blocks are automatically depressurized

- Increases the service life of the valves
- The depressurization unit integrated in the valve block enables particularly low installation effort and significant cost reduction
- No need for manual adjustment of the excavator hydraulics
- Automatically activated by pressing unlock button

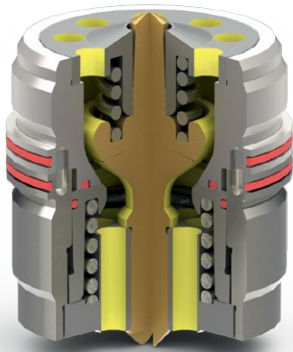

Engaged valve



Disengaged valve

All four working valves become pressureless when opening the quick coupler through this valve

Automatic control for pressureless valve while unlocking the QC

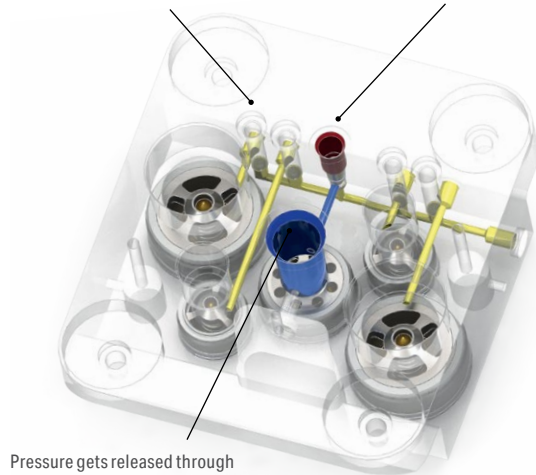

Pressure gets released through the oil leakage line



Valve change at SQ-V

\*Not applicable to SQ90V models

## SQ-V valve blocks

### Valve configurations\*\*\*

#### S-block: Valve block in the quick coupler

- Five symmetrically arranged short-stroke valves
- Included oil drain line
- Integrated hydraulic tensioning device for firm hydraulic connections
- Optional electrical feed (EF)

#### A-block: Valve block in the attachment

- Five symmetrically arranged short-stroke valves to mate with S-block
- Valve configuration designed to match specific hydraulic attachments
- Unused auxiliary lines are easily capped with flat "blank valves"
- Optional electrical feed (EF)

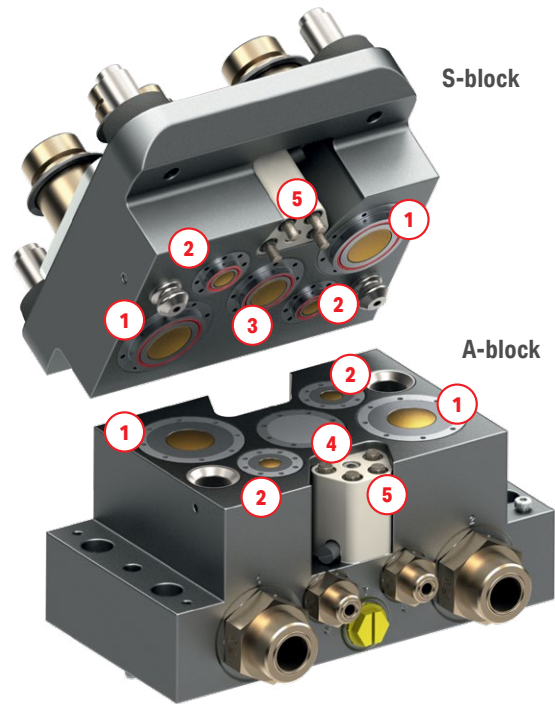

#### A-block valve configurations

(examples, but not limited to the attachments below)

hydraulic hammer



2 valves

drum cutter/ compactor



3 valves

sorting grapple/shear



4 valves

rotating compactor



5 valves

- ① High-flow (1st ATT) line
- ② Low-flow (2nd ATT) line
- ③ Oil drain line
- ④ Blank valve
- ⑤ Optional electrical feed (EF)

red = active valves white = blank valves

Lehnhoff S-block valve specifications		SQ60V			SQ70V/ SQ70-55V/SQ80V	
Type	Size	Flow rate (ca. gpm)	Number of valves	Number of valves	Number of valves	
KV1	1/2" ORFS-8	29	3	2		
KV2	5/8" ORFS-10	42	-	-		
KV3	3/4" ORFS-12	63	2	1		
KV4	1" ORFS-16	145	-	2		
KV6	1 1/4" ORFS-20	198	-	-		

		SQ90V		
Type	Size	Flow rate (ca. gpm)	Number of valves	
KV1	1/2" ORFS-8	29	2 + (1*)	
KV2	5/8" ORFS-10	42	-	
KV3	1/2" ORFS-8	63	1+(1**)	
KV4	1" ORFS-16	145	-	
KV6	1 1/4" ORFS-20	198	2	

#### Optional for SQ90V:

*KV1	M10 x 1	29	Grease supply
**KV3	1/2" ORFS-8	63	Water supply

Note: The specified flow rate refers only to the short-stroke valve.

\*SQV90 valve block may differ from the image shown.

\*\*\*Configuration shown is only valid for SQ60V, SQ70V, SQ70-55V and SQ80V



# Lehnhoff Fully Automatic Symmetric Quick Coupler (SQ-V)

## SQ adapters: Suitable for attachments of all types and brands

No matter which brand of attachments you want to connect to your excavator, rigid or hydraulic — we can offer SQ adapters for all options. Thanks to the defined S standard, all SQ adapters for rigid attachments in each class will fit all couplers that use the S standard\*.

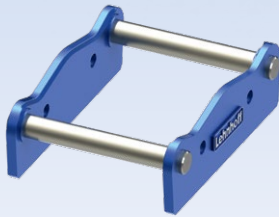

**Adapter frame**  
for rigid attachments,  
e.g. bucket conversions (also  
available with base plate)

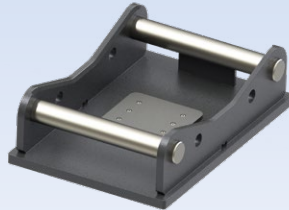

**Adapter with base plate**  
for rigid attachments, e.g. bucket  
conversions. Image shows adapter for  
SQ-V with valve protection plate.



**Universal adapter SQ-V**  
with valve block and adapter can  
be welded or holes can be drilled to  
accommodate any attachment



**Bolt-on adapter**  
with valve block and hole  
pattern predrilled for a  
specific attachment

## LSC safety assistance system

Lehnhoff Safety Control (LSC) offers control of all operating states of the quick coupler from the driver's cab. If LSC detects a faulty connection, it will display a warning so the operator can take action.

- Monitoring of conditions via integrated sensors
- Illuminated optical display and acoustic signals
- Control of the operating states via the LSC control unit mounted in the cab
- Two-finger operation of the unlocking function prevents accidental unlocking of the coupler
- Standard with all new Lehnhoff SQ quick coupler systems
- Complies with ISO 13031



Quick coupler  
locked

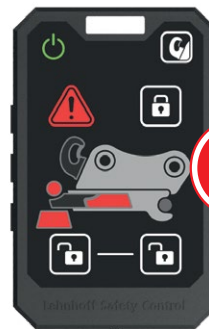

Quick coupler  
not locked



\*Compatibility between different manufacturers is only given for rigid attachments

# Lehnhoff Fully Automatic Symmetric Quick Coupler (SQ-V)



## Lehnhoff fully automatic symmetric quick coupler (SQ-V)

	SQ60V	SQ70V	SQ70-55V	SQ80V	SQ90V
Excavator class (lbs.)*	17,640 - 39,685	33,070 - 61,730	39,685 - 70,550	55,115 - 94,800	88,185 - 154,325
Pick-up shaft dia. (in)	2.36	2.76	2.76	3.15	3.54
Axle spacing (in)	18.90	23.62	23.62	26.38	29.53
Width (in)	13.31	17.64	21.65	23.15	29.45
Approximate weight (lbs.)**	375	617	705	948	1,631
Standard valve configuration	3 × KV1 2 × KV3	2 × KV1 2 × KV4 1 × KV3	2 × KV1 2 × KV4 1 × KV3	2 × KV1 2 × KV4 1 × KV3	2 × KV1 1 × KV3 2 × KV6
Recommended Komatsu excavator available in U.S. market	PC78-PC170	PC138-PC240	PC170-PC290	PC238-PC390	PC490-PC650

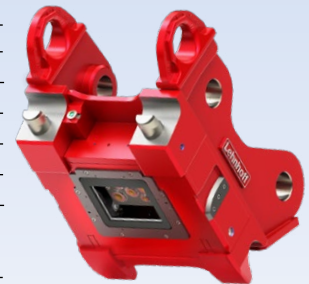

\* Rough classification. Suspension and maximum break-out force of excavator must be considered.

\*\* Dependent upon excavator specific suspension





Contact your Komatsu distributor to place your Lehnhoff quick coupler order.

---

Product designs, specifications and/or data in this document are provided for informational purposes only and are not warranties of any kind. Product designs and/or specifications may be changed at any time without notice. The only warranties that apply to sales of products and services are Komatsu's standard written warranties, which will be furnished upon request.

Komatsu and other trademarks and service marks used herein are the property of Komatsu Ltd., its subsidiaries, or the respective owners or licensees.

**KOMATSU**

[komatsu.com](https://www.komatsu.com)

