

# KOMATSU®

## WA600-8

EPA Tier 4 Final Engine

Australia & New Zealand Specifications

WHEEL LOADER



Photos may include optional equipment.

**NET HORSEPOWER**

395 kW / 529 HP @ 1800 rpm

**OPERATING WEIGHT**

55,400 – 57,460 kg

**BUCKET CAPACITY**

6.4 – 7.8 m<sup>3</sup>

WA600

# WALK-AROUND

WA600-8



Photos may include optional equipment.

## NET HORSEPOWER

395 kW / 529 HP @ 1800 rpm

## OPERATING WEIGHT

55,400 – 57,460 kg

## BUCKET CAPACITY

6.4 – 7.8 m<sup>3</sup>

## PERFORMANCE, DURABILITY AND FUEL ECONOMY

### Large capacity torque converter with lock-up provides:

- Quick acceleration
- Lock-up in 2<sup>nd</sup>, 3<sup>rd</sup> and 4<sup>th</sup> gear

**Komatsu SmartLoader Logic** helps reduce fuel consumption with no decrease in production.

A powerful **Komatsu SAA6D170E-7 engine** provides a net output of 395 kW 529 HP with up to 13% improved fuel consumption in E mode and up to 7% in P mode. This engine is EPA Tier 4 Final emissions certified.

**Komatsu Variable Geometry Turbocharger (KVGT)** uses a hydraulic actuator to provide optimum air flow under all speed and load conditions.

**Komatsu Diesel Particulate Filter (KDPF) and Selective Catalytic Reduction (SCR) systems** reduce particulate matter and NOx while providing automatic regeneration that does not interfere with daily operation.

**Variable traction control system and modulated clutch system** provide optimal tractive effort for all ground conditions.

### Cooling

- Hydraulically driven, variable speed fan
- Reversing fan is standard
- Wider core coolers resist clogging
- Fan swings out for easy cleaning

**Remote boom and bucket positioners** allow kick-outs to be set from inside the cab.

**Variable displacement piston pumps with Closed-centre Load Sensing System (CLSS)** provide quick response and smooth operation to maximise productivity.

### Rearview monitoring system (standard)

**Advanced diagnostic system** continuously monitors machine operation and vital systems to identify machine issues and assist with troubleshooting.

### Enhanced working environment:

- High capacity, heated, air suspension seat
- Seat mounted Advanced Joystick Steering System (AJSS) and Electronic Pilot Control (EPC) controls
- Two 12V power outlets

**Full rear fenders** with stairs and handrails are standard for both sides of the machine. The RH fender has a door for convenient access to daily maintenance points.



### Large LCD colour monitor panel:

- 7" high resolution, multi-colour screen is easy to read
- Integrated load meter system displays payload data directly on the monitor panel
- Includes an ecology gauge and provides "Ecology Guidance" for greater fuel efficiency
- Onboard diagnostics do not require use of a laptop computer
- Easy-to-navigate menus allow operators to change settings, review machine performance records, and track periodic maintenance items.

**Komatsu Auto Idle Shutdown** helps reduce idle time and operating costs.

**KOMTRAX®** equipped machines can send location, SMR and operation maps to a secure website or smart phone. Machines also relay error codes, cautions, maintenance items, fuel & Diesel Exhaust Fluid (DEF) levels, payload data, and much more.

**KOMTRAX Plus** function expands machine monitoring capabilities to include component condition and trend data.

**Advanced Joystick Steering System (AJSS)** provides feedback so the machine steering angle is consistent with the steering joystick angle.

**Operator Identification System** can track machine operation for up to 100 operators.

# PRODUCTIVITY & ECOLOGY FEATURES

## KOMATSU NEW ENGINE TECHNOLOGIES

### Komatsu's New Emission Regulations-compliant Engine

New regulations effective in 2018 require the reduction of NOx emissions to one tenth or below from the preceding regulations. In addition to refining the Tier 4 Interim technologies, Komatsu has developed a new selective catalytic reduction (SCR) device in-house.

### Technologies Applied to New Engine

#### Heavy-duty aftertreatment system

This new system combines a Komatsu Diesel Particulate Filter (KDPF) and Selective Catalytic Reduction (SCR). The SCR NOx reduction system injects the correct amount of Diesel Exhaust Fluid (DEF) at the proper rate, thereby decomposing NOx into non-toxic water vapour (H<sub>2</sub>O) and nitrogen gas (N<sub>2</sub>).

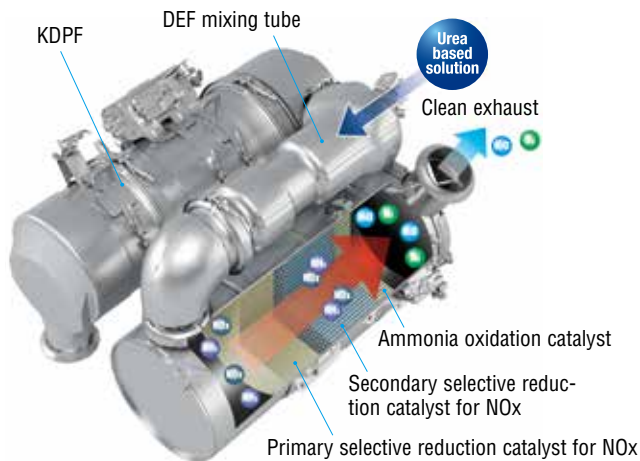

#### Heavy-duty cooled Exhaust Gas Recirculation (EGR) system

The system recirculates a portion of exhaust gas into the air intake and lowers combustion temperatures, thereby reducing NOx emissions. While EGR gas flow is increased, by incorporating a high-efficiency and compactly designed cooling system, the system achieves a dynamic reduction of NOx, helping to reduce fuel consumption.

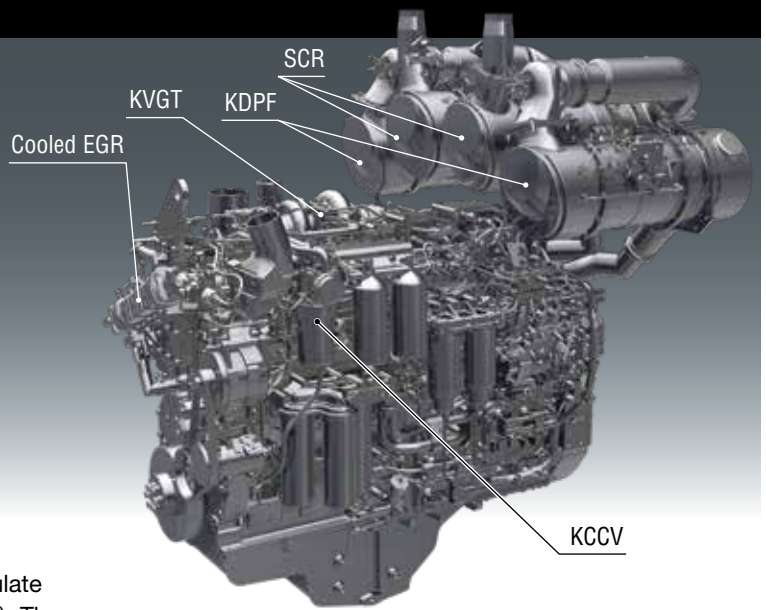
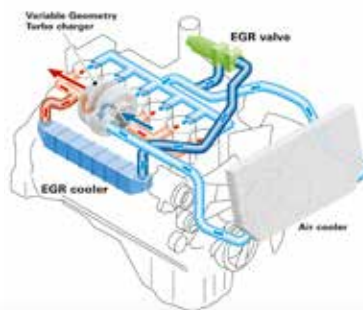

#### Electronic Control System

The electronic control system performs high-speed processing of all signals from sensors installed in the vehicle and engine. This ensures total control of equipment. Engine condition information is displayed on the monitor inside the cab, providing necessary information to the operator. Additionally, managing the information via KOMTRAX Plus helps customers keep up with required maintenance.

#### Komatsu Variable Geometry Turbocharger (KVG) system

The KVG system features Komatsu designed hydraulic technology for variable control of air-flow and supplies optimal air according to load conditions. The upgraded version provides better exhaust temperature management.

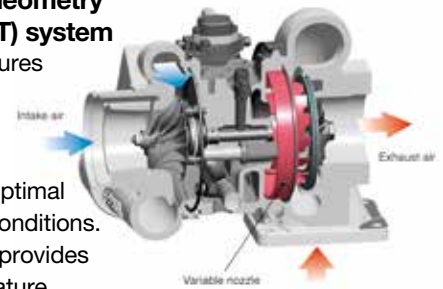

#### Heavy-duty High-Pressure Common Rail (HPCR) fuel injection system

The system is designed to achieve an optimal injection of high-pressure fuel digitally, thereby achieving near complete combustion to reduce particulate matter (PM) emissions.

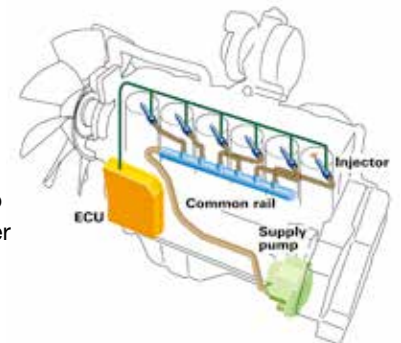

W4600-8

## Low Fuel Consumption

By optimally controlling engine power and creating a high efficiency power train and hydraulic system, new features on the WA600-8 reduce fuel consumption, while enhancing fuel efficiency.

**Fuel consumption reduced by up to 13% in Economy mode**

\* Compared with the WA600-6, fuel consumption varies depending on working conditions.

## Komatsu SmartLoader Logic

The WA600-8 provides Komatsu SmartLoader Logic, an engine control system. This technology creates the right amount of torque for each work phase. For example, engine torque needs are higher for digging in V-shape loading, but less when driving with an empty bucket. This system optimises the engine torque for all applications to minimise fuel consumption. Komatsu SmartLoader Logic functions automatically and doesn't interfere with operation, saving fuel without decreasing production.

## Large-capacity Torque Converter

The Komatsu-designed power train has a large capacity torque converter for optimum efficiency. The WA600-8 has greater productivity in V-shape loading applications because the increased tractive effort does not require full throttle. The improved hill climbing ability allows the WA600-8 to up-shift gears faster because of improved acceleration. The WA600-8 can achieve higher gear ranges and maintain higher travel speed when working in load-and-carry applications. In most applications, production is increased and fuel consumption is reduced, resulting in improved fuel efficiency.

## Enhanced Lock-up

The Komatsu designed torque converter with lock-up is standard on the WA600-8. The lock-up function activates in 2nd, 3rd and 4th gears. The lock-up torque converter is effective for both load-and-carry application and V-shape loading, which uses lower gears. Komatsu SmartLoader Logic reduces the clutch engagement shock of lock-up by controlling engine torque. The lock-up torque converter, combined with Komatsu SmartLoader Logic, results in low fuel consumption and high travel speeds in load-and-carry and even some cycle-loading applications.

## Variable Displacement Piston Pump & CLSS

The variable displacement piston pump combined with the Closed-centre Load Sensing System (CLSS) delivers hydraulic flow just as the job requires, preventing wasted hydraulic flow. Minimised loss contributes to better fuel economy.

## Automatic Digging System

New automatic digging system actuates the bucket tilt and lifting operations by sensing the pressure applied to the work equipment. This system can alleviate operator's fatigue and optimise bucket load.



## Two-mode Engine Power Select System

This wheel loader offers two selectable engine power modes — Economy and Power.

- E Mode: This mode provides maximum fuel efficiency for general loading.
- P Mode: This mode provides maximum power output for hard digging operation or hill climbing.



Power mode selector switch

## Komatsu Auto Idle Shutdown

In order to reduce idle time, Komatsu offers Auto Idle Shutdown. This function will shut the engine off and apply the parking brake and hydraulic lock after a preset idle time limit.



# OPERATOR ENVIRONMENT



W4600-8

## New Operator Seat with Electronic Pilot Control (EPC) Levers

A new heated, air suspension seat provides enhanced support on rough roads and dampens machine vibrations, providing a more comfortable ride for the operator. An EPC lever console and advanced joystick steering lever are integrated in, and move with, the seat. The angle of the armrest is fully adjustable for optimum operator comfort.



## Low Noise Design

The large cab, ROPS/FOPS, is mounted with Komatsu's unique viscous mounts. The low-noise engine, hydraulically driven fan, and hydraulic pumps are mounted with rubber cushions, and the cab sealing is improved to provide a quiet, low-vibration, and comfortable operating environment. The cab is pressurised to minimise dust.

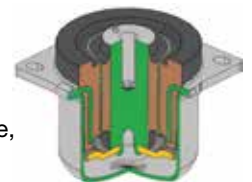

Operator's ear noise level	76 dB(A)
Dynamic noise level (outside)	113 dB(A)

## Advanced Joystick Steering System (AJSS)

Advanced Joystick Steering System allows steering and directional selection to be controlled by wrist and finger control. With the feedback function, the machine steering angle is exactly the same as the lever tilt angle.

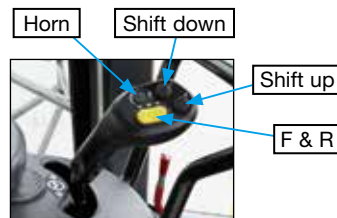

## Integrated Load Meter

The Komatsu integrated load meter system displays payload data directly on the monitor panel. Payload data is also accessible remotely via KOMTRAX Plus.



### Rear View Monitoring System

The operator can view the rear of the machine with a full colour monitor that is located on the right side of the cab. This monitor can be always on or only on when the loader goes into reverse. Visual guidelines can also be added for more convenience.



### Pillar-less Large Cab with ROPS/FOPS

The ROPS/FOPS Cab is standard for operator's safety. A wide pillar-less flat glass window provides excellent front visibility. A heated rear window provides excellent rear visibility in cold weather conditions.

ROPS (ISO 3471) : Roll-over Protective Structure  
 FOPS (ISO 3449) : Falling Objects Protective Structure



### Automatic Climate Control System

The automatic climate control system allows the operator to easily and precisely set the cab temperature using the large LCD colour monitor panel. The bi-level control function improves air flow and keeps the inside of the cab comfortable throughout the year.



### Seat Belt Caution Indicator

A warning indicator on the monitor appears when the seat belt is not engaged.



## Standard Equipment

Lunch box tray



Hot or cool box



- ① Auxiliary input (MP3 jack)
- ② 12 V outlets

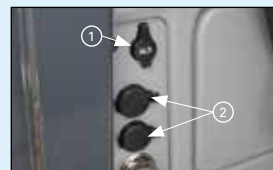

- ① Steering lock lever
- ② Work equipment lock switch

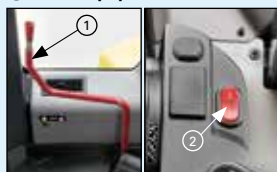

Engine shutdown secondary switch

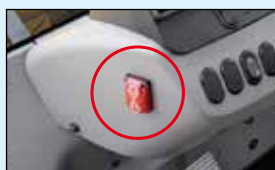

Parking brake switch



# OPERATOR ENVIRONMENT

## Automatic Transmission

Automatic transmission with electronically controlled modulation valve automatically selects the proper gear speed, based on travel speed, engine speed and other travel conditions. The electronically controlled modulation valve system engages the clutch smoothly to prevent lags and shocks when shifting. This system provides efficient machine operation and a comfortable ride.

## Mode Select System

This operator controlled system allows the operator to select manual shifting or automatic shifting.

## Auto Kick-Down

Downshifting from second to first speed range can be done automatically without pushing the kick-down switch when beginning digging cycle. It automatically upshifts from first to second when the direction control lever is placed in reverse. This results in easy operation, increased rim pull for better bucket penetration and reduced cycle times for higher productivity.

It can be changed to manual control by the kick-down switch setting through the monitor.

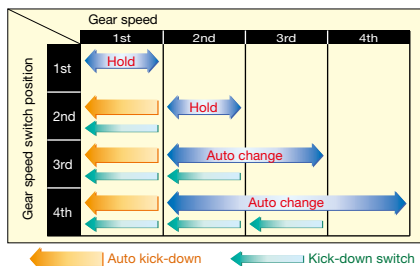

## Hold Switch

When in automatic shifting mode, the Hold switch can be used to hold the speed range at 3rd or 4th gear position for uphill travel.

## Remote Bucket & Boom Positioner with Shockless Stop Function

The operator can set the bucket angle and remote boom positioner from the cab. Once the positioner is set, the bucket is smoothly stopped at the desired position with no shock. Both the upper and lower boom positions are adjustable in the cab with the push of a button.

## Work Equipment Shock Reduction Control

Stroke-end shock of the work equipment can be customised to reduce operator fatigue and accommodate different loading applications (i.e. loose material). There are four settings (Low, Medium, High and Off). The operator can easily choose one through the monitor panel.



## Engine RPM Set System with Auto Deceleration

Engine low idle RPM can be easily preset using a push button switch. The system also provides auto deceleration for better fuel consumption.



- 1 Hold switch
- 2 Kick-down switch
- 3 Variable traction control dial
- 4 Auto shift selector switch
- 5 Remote positioner switch
- 6 RPM set switch

## Variable Traction Control System

In limited traction situations, where the operator wants to avoid tyre slippage (such as sandy or muddy ground operation) the operator can activate the variable traction control system. The optimum rim pull (F1) is controlled by adjusting the control knob from 100% to 20%.



## Modulated Clutch System

The modulated clutch system controls the tractive effort with the left brake pedal from 100% to 20% of the converter output torque.

- Useful for smooth speed reduction when approaching dump trucks for loading.
- Easy control of tyre slippage.
- Reduction of shocks in shifting from forward to reverse.

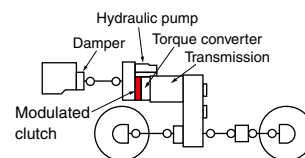
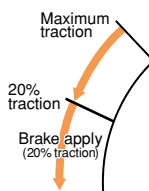

## Electronically Controlled Suspension System

The electronically controlled suspension system or ride control system uses an accumulator which absorbs some of the shock in the boom arm, giving the operator a much smoother ride. This reduces operator fatigue and reduces material spillage during load-and-carry operations. The electronically controlled suspension system is speed sensitive; This ensures that the boom cushioning function doesn't interfere with stationary digging.

# TECHNOLOGY

## High Resolution 7-inch Colour LCD Monitor

The machine monitor displays various machine information and allows for various settings of the machine. The LCD monitor is a 7-inch colour LCD and displays maintenance information, operation records, ecology guidance records, etc. The switch panel is used to select various screens and the air conditioner control screen. By using the switch panel, you can display various user menus on the LCD screen and adjust machine settings.

### Machine monitor

- |                           |  |
|---------------------------|--|
| ① LCD unit                | ⑧ Engine coolant temperature gauge       |
| ② LED unit                | ⑨ Hydraulic oil temperature gauge        |
| ③ Engine tachometer       | ⑩ Torque converter oil temperature gauge |
| ④ Speedometer             | ⑪ Fuel gauge                             |
| ⑤ Ecology gauge           | ⑫ Message pilot lamp                     |
| ⑥ Air conditioner display | ⑬ Pilot lamps                            |
| ⑦ Shift indicator         | ⑭ DEF level gauge                        |

### Switch panel

- |  |                     |
|--|---------------------|
| ① Air conditioner switches / Numeral key pad | ② Function switches |
|--|---------------------|



## Visual User Menu

Pressing the menu switch on the switch panel displays the user menu screen. The menus are grouped for each function, use easy-to-understand icons enable intuitive machine operation.



## Energy Saving Operation Ecology Guidance

In order to support optimum operation, an easy-to-read "Ecology gauge" is displayed on the machine monitor screen. In addition, the following seven guidance messages are displayed for fuel saving operation.

- 1) Excessive engine idling event
- 2) Hydraulic relief pressure event
- 3) Dragging of brake event
- 4) Excessive stepping on accelerator event
- 5) Recommendation of 4th gear
- 6) Recommendation of lock-up
- 7) Excessive digging event



## Operator Identification Function

An operator identification can be set for each operator, and used to manage operation information of individual machines as KOMTRAX data. Data sent from KOMTRAX Plus can be used to analyse operation status by operator, as well as by machine.



## Machine Monitor with Troubleshooting Function to Minimise Downtime

Various meters, gauges and warning functions are centrally arranged on the machine monitor. The monitor simplifies start-up inspection and promptly warns the operator with a lamp and buzzer if any abnormalities should occur. In addition, abnormalities are indicated in four levels to identify proper level and urgency of response.



## Operation Records, Fuel Consumption History, and Ecology Guidance Records

The ecology guidance menu enables the operator to check fuel consumption history, operation, and ecology guidance records by pushing a button. The records can be used to reduce overall fuel consumption.



Operation record



Fuel consumption record

# MAINTENANCE FEATURES



WA600-8

## Side-Opening Engine Doors

A wide access area makes daily maintenance easy. Large steps are provided on each side of the frame for added convenience.



## Swing-out Type Cooling Fan and Wide Core Radiator

The cooling fan swings out for easy cleaning. The coolers feature wide spacing of the cooling fins to reduce clogging.



## Reversing Fan

The engine cooling fan is driven hydraulically. The reversible fan can be controlled through the monitor.



## DEF Tank

The DEF tank is located on the right hand side of the machine, at ground level, behind a ladder, for easy access. An external sight gauge aids in preventing overflow and spillage while refilling.



## Battery Isolation Switch

The battery isolation switch is located on the left hand side of the machine at ground level. This can be used to disconnect power when performing service work. A padlock can be installed to lockout the machine.



### Engine Compartment

The WA600-8 engine compartment is configured for easy serviceability. Special attention was paid to the location of maintenance items, such as the filters, dipsticks and oil fill locations. The aftertreatment devices are also easy to access.



### Rear Full Fenders

Rear full fenders with steps and handrails are standard at both sides of the machine. The fenders protect the machine from material that may be thrown by the tyres and give the technician easy access to the engine compartment.



### Air Cab Filter

The inside and outside cab air filters can be replaced easily without the need for tools.



Inside air filter

Outside air filter

### LED Taillights

LED brake lights and LED reverse lights provide long bulb life.



### Modular Radiator Core System

The modular radiator core can be removed without removing the entire radiator assembly.



### Maintenance Information

#### “Maintenance time caution lamp” display

When the remaining time to maintenance becomes less than 30 hours\*, the maintenance time monitor appears. Pressing the menu switch displays the maintenance screen.

\* : The setting can be changed within the range between 10 and 200 hours.



Maintenance screen

#### DEF level and refill timing

The DEF level gauge is displayed continuously on the monitor screen. In addition, when the refill timing is reached, the DEF low level guidance appears as a pop up display to inform the operator in real time.



DEF level gauge



DEF low level guidance

# KOMTRAX EQUIPMENT MONITORING

GET THE WHOLE STORY WITH  
**KOMTRAX**®

## ✓ WHAT

- KOMTRAX is Komatsu's remote equipment monitoring and management system
- KOMTRAX **continuously monitors and records** machine health and operational data
- Information such as fuel consumption, utilisation, and a detailed history **lowering owning and operating cost**

## ✓ WHO

- KOMTRAX is **standard** equipment on all Komatsu construction products

## ✓ WHEN

- Know when your machines are **running or idling** and make decisions that will improve your fleet utilisation
- Detailed movement records ensure you know when and where your equipment is moved
- Up to date records allow you to **know when maintenance is due** and help you plan for future maintenance needs

## ✓ WHERE

- KOMTRAX data **can be accessed virtually anywhere** through your computer, the web or your smart phone
- Automatic alerts keep fleet managers up to date on the latest machine notifications

## ✓ WHY

- Knowledge is power - **make informed decisions** to manage your fleet better
- Knowing your idle time and fuel consumption will help maximise your machine efficiency
- **Take control of your equipment** - any time, anywhere



## **KOMTRAX Plus**™

**Assists Customer's Equipment Management and Contributes to Fuel Cost Cutting**

### Equipment Management Support

KOMTRAX Plus enables expanded monitoring of the fleet via satellite and wireless LAN. Users can analyse "machine health" and performance from a remote location, on a near-real time basis. This includes component condition and trend data. By making this critical information readily accessible, KOMTRAX Plus is an effective tool in maximizing productivity and lowering operating costs.

# KOMATSU iSITE

## Your fleet management solution

Komatsu iSite is an agnostic fleet management solution targeted at quarry and large construction projects. Komatsu iSite provides simple in-cab automated operation, with sophisticated real-time monitoring that is sent directly to the office or mobile enabled devices. This realtime data aggregation is visualised through industry leading dashboards - built with the industry voice in mind. The PreStart module allows for electronic pre-starts checks, plus auto-generated reporting and email notifications.

### KALSS - Australia Standard Specifications

#### Standard options - hardware

- XD8 8" HD ruggedised operator panel
- 3:1 Antenna [GNSS/WIFI/LTE]
- BM2 ruggedised multi-OEM interface cable
- XD8 power cable



Komatsu iSite, comes standard with every HD605-8.\*

### Options for Komatsu iSite

#### Onsite commissioning for each machine

#### Standard options - software

- Specific vehicle firmware / software
- Remote access availability to the connected machine
- 3 x STD Komatsu iSite dashboards
- PreStart with email notification and reporting
- iControl PC installation application

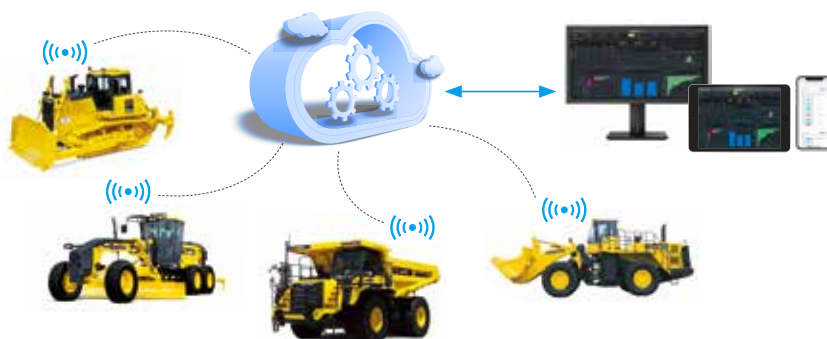

\* Smart Construction Division to conduct a Komatsu iSite readiness survey at each site prior to quoting and first deployment.

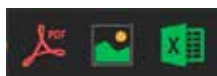

Dashboard exporting available .CSV, .PDF and .JPEG formats

### Current dashboards - available

- Utilisation dashboard** - included in standard package.
- Fuel dashboard** - included in standard package.
- Fleet focus** - included in standard package.
- Product (trucks) dashboard** - optional.
- Operator scorecard** - optional.

\* Dashboards are part of the SaaS - Software as a Service connected to your Komatsu iSite fleet management solution they can be packaged to suit your requirements.

\*Activation is optional. Additional costs apply.

# SPECIFICATIONS

## ENGINE

Model ..... Komatsu SAA6D170E-7\*  
 Type ..... Water-cooled, 4-cycle  
 Aspiration ..... Komatsu variable geometry, turbo-charged,  
 after-cooled, cooled EGR  
 Number of cylinders ..... 6  
 Bore ..... 170 mm  
 Stroke ..... 170 mm  
 Piston displacement ..... 23.15 ltr  
 Governor ..... All-speed, electronic  
 Horsepower:  
 SAE J1995 ..... Gross 396 kW 530 HP  
 ISO 9249 / SAE J1349 ..... Net 395 kW 529 HP  
 Rated rpm ..... 1800 rpm  
 Fan drive method for radiator cooling ..... Hydraulic  
 Fuel system ..... Direct injection  
 Lubrication system:  
 Method ..... Gear pump, force-lubrication  
 Filter ..... Full-flow type  
 Air cleaner ..... Dry type with double elements and  
 dust evacuator, plus dust indicator

\*EPA Tier 4 Final emissions certified

## TRANSMISSION

Torque converter ..... three-elements, one-stage, two-phase  
 Transmission ..... Automatic full-powershift, planetary type

Travel speed	Forward*	Reverse*
1st	6.7 km/h	7.3 km/h
2nd	11.7 km/h (12.4 km/h)	12.8 km/h (13.5 km/h)
3rd	20.3 km/h (21.7 km/h)	22.0 km/h (23.7 km/h)
4th	33.8 km/h (37.7 km/h)	37.0 km/h (41.0 km/h)

\*P-mode Measured with 35/65-33 tyres ( ): Lock-up clutch ON

## AXLES AND FINAL DRIVES

Drive system ..... Four-wheel drive  
 Front ..... Fixed, full-floating  
 Rear ..... Centre-pin support, full-floating,  
 22° total oscillation  
 Reduction gear ..... Spiral bevel gear  
 Differential gear ..... Conventional type  
 Final reduction gear ..... Planetary gear, single reduction

## BRAKES

Service brakes ..... Hydraulically actuated,  
 wet multiple-disc brakes actuate on four wheels  
 Parking brake ..... Wet multiple-disc brake  
 Emergency brake ..... One of dual service brake circuits  
 is commonly used



## STEERING SYSTEM

Type ..... Articulated type, fully-hydraulic power steering  
 Steering angle ..... 43° each direction  
 Minimum turning radius at  
 the centre of outside tyre ..... 7075 mm



## HYDRAULIC SYSTEM

Steering system:  
 Hydraulic pump ..... Piston type  
 Capacity ..... 163 ltr/min at rated rpm  
 Relief valve setting ..... 34.3 MPa 350 kgf/cm<sup>2</sup>  
 Hydraulic cylinders:  
 Type ..... Double-acting, piston type  
 Number of cylinders ..... 2  
 Bore x stroke ..... 100 mm x 486 mm

Loader control:  
 Hydraulic pump ..... Piston pump  
 Capacity ..... 239 + 239 ltr/min  
 at rated rpm  
 Relief valve setting ..... 34.3 MPa 350 kgf/cm<sup>2</sup>  
 Hydraulic cylinders:  
 Type ..... Double-acting, piston type  
 Number of cylinders—bore x stroke:  
 Boom cylinder ..... 2- 200 mm x 1067 mm  
 Bucket cylinder ..... 1- 225 mm x 776 mm  
 Control valve ..... 2-spool type  
 Control positions:  
 Boom ..... Raise, hold, lower, and float  
 Bucket ..... Tilt-back, hold, and dump  
 Hydraulic cycle time (rated load in bucket)  
 Raise ..... 8.7 s  
 Dump ..... 2.3 s  
 Lower (Empty) ..... 4.1 s



## SERVICE REFILL CAPACITIES

Cooling system ..... 150 ltr  
 Fuel tank ..... 718 ltr  
 Engine ..... 86 ltr  
 Hydraulic system ..... 443 ltr  
 Axle front ..... 185 ltr  
 rear ..... 193 ltr  
 Torque converter and transmission ..... 78 ltr  
 DEF tank ..... 60 ltr



## BUCKET SELECTION GUIDE

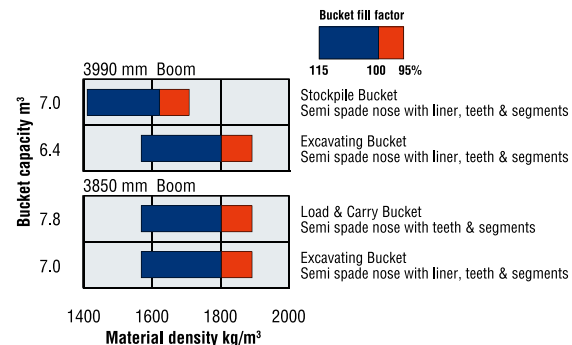



## DIMENSIONS

Measured with 35/65-33-36PR (L-4) tyres, ROPS/FOPS cab

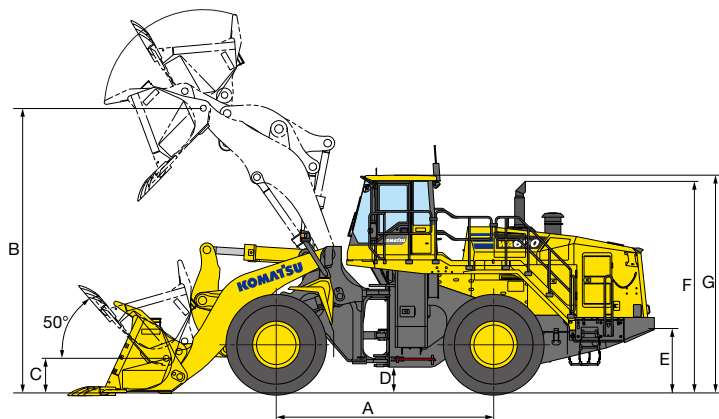

Tread width (centre of tread to centre of tread)	2650 mm	
Width over tyres	3590 mm	
A Wheelbase	4500 mm	
B Hinge pin height,	3850 mm boom	5665 mm
max. height	3990 mm boom	5885 mm
C Hinge pin height,	3850 mm boom	670 mm
carry position	3990 mm boom	720 mm
D Ground clearance	525 mm	
E Hitch height	1320 mm	
F Overall height, top of the stack	4375 mm	
G Overall height, ROPS cab	4500 mm	

	3990 mm Boom		3850 mm Boom	
	Excavating Bucket	Stockpile Bucket	Excavating Bucket	Load & Carry Bucket
	Spade nose Teeth and BSE *1	Spade nose Teeth and BSE *1	Spade nose Teeth and BSE *1	Spade nose Teeth and BSE *1
Bucket capacity: heaped	6.4 m <sup>3</sup>	7.0 m <sup>3</sup>	7.0 m <sup>3</sup>	7.8 m <sup>3</sup>
struck	5.3 m <sup>3</sup>	5.8 m <sup>3</sup>	5.8 m <sup>3</sup>	6.6 m <sup>3</sup>
Bucket width	3805 mm	3805 mm	3805 mm	3805 mm
Bucket weight	5975 kg	6152 kg	6152 kg	5791 kg
Dumping clearance, max. height and 45° dump angle *2	3965 mm	3915 mm	3700 mm	3615 mm
Reach at max. height and 45° dump angle *2	1835 mm	1885 mm	1915 mm	2000 mm
Reach at 2130 mm clearance and 45° dump angle	3030 mm	3065 mm	2920 mm	2970 mm
Reach with arm horizontal and bucket level*	4175 mm	4245 mm	4105 mm	4225 mm
Operating height (fully raised)	7925 mm	8040 mm	7280 mm	7885 mm
Overall length (bucket on ground)	12145 mm	12215 mm	12030 mm	12150 mm
Loader clearance circle (bucket at carry, outside corner of bucket)	17050 mm	17090 mm	16770 mm	16990 mm
Digging depth: 0°	130 mm	130 mm	130 mm	130 mm
10°	530 mm	540 mm	540 mm	560 mm
Static tipping load: straight	38220 kg	38036 kg	37845 kg	43265 kg
40° full turn	32675 kg	32520 kg	32805 kg	37080 kg
Breakout force	385 kN 39500 kgf	370 kN 38200 kgf	375 kN 38600 kgf	355 kN 36200 kgf
Operating weight	56280 kg	56460 kg	55400 kg	57460 kg

\*1 Bolt-on segment edges. \*2 At the end of the tooth

All dimensions, weights, and performance values based on SAE J732c and J742b standards.

Static tipping load, operating weight and overall length shown include lubricant, coolant, full fuel tank, ROPS cab, and operator.

Machine stability and operating weight affected by counterweight, tyre size, and other attachments.

Apply the following weight changes to operating weight, static tipping load and overall length.

# SPECIFICATIONS



## WEIGHT CHANGES

Tyres or attachments	Operating weight	Tipping load straight		Tipping load full turn		Width over tyres	Ground clearance	Change in vertical dimensions
		3990 mm Boom	3850 mm Boom	3990 mm Boom	3850 mm Boom			
	kg	kg	kg	kg	kg	mm	mm	mm
35/65-R33 (L-4)	-780	-565	-585	-485	-500	3615	460	-65
35/65-R33 (L-5)	-235	-175	-180	-150	-150	3615	460	-65



## STANDARD EQUIPMENT

### ENGINE:

- Air cleaner, double element with dust indicator
- Engine, Komatsu SAA6D170E-7 diesel
- Fuel pre-filter with water separator
- Hydraulic-driven fan with reverse rotation
- KDPF, SCR
- Komatsu SmartLoader Logic
- Pre-cleaner, 2x centrifugal type
- Radiator mask, swing out
- Radiator, modulating core

### ELECTRICAL SYSTEM:

- Alternator, 140 A, 24 V
- Batteries, large capacity, 2 x 12 V / 200 Ah
- Circuit breaker
- Komatsu Auto Idle Shutdown
- Lights
  - Access stair lamp, LH side
  - Back-up lights, LED
  - Directional signal
  - Engine bay light.
  - Front work Lamps, 2x Axle, LED, guarded.
  - Front work lamps, 2x Cabin, Halogen.
  - Hazard lamps
  - Head lamps, LH and RH side
  - LED Beacon & Guard.
  - Rear work lamps, 2x Cabin, 2x Radiator, Halogen
  - Side work lights, 2x LH and RH Side, LED.
  - Stop and tail lamps, LED and turn signal lamp
- Starting motor, 24 V x 2 / 11.0 kW

### CAB:

- 2 x DC12V electrical outlets
- Advanced Steering System
- Auto air conditioner
- AM/FM radio with AUX input jack
- Colour multi-monitor
- Electronically Controlled Suspension System (ECSS)
- Electronic pilot control fingertip control
- Floor mat
- Front wiper (with washer and intermittent)
- Rear defroster (electric)
- Rear window washer and wiper
- ROPS/FOPS (ISO 3471/ISO 3449) cab
- Seat, suspension type with reclining
- Seat belt (two-point)
- Starter receptacle
- Sun visor

### SAFETY EQUIPMENT:

- Back-up alarm
- Coxon pressure release radiator cap
- Emergency Egress Gate
- Emergency Stop Switch, 1x Cab, 3x External, ground level
- Emergency/Secondary Steering system
- Engine shutdown secondary switch
- Hand rails for platform
- Handrails, full deck and 100mm kickplates
- Horn, electric
- Lockable battery isolation switch
- Lockable starter isolation switch
- Parking brake, electric
- Rear view mirrors
- Rear view monitoring system
- Service brakes, wet disk type
- Wheel Chock

### TYRES:

- 35/65R33(L5) – WA600-8
- 35-65R33(L4) – WA600-8LC
- Large bore tyre valves

### OTHER:

- 2-spool valve for boom and bucket control
- 3990 mm boom
- Additional counterweight (850 kg)
- Automatic digging system
- Automatic Greasing System, ground level refill
- Automatic shift transmission
- Brake cooling system
- Counterweight, standard
- Ecology guidance, ecology gauge
- Engine RPM set system
- Fast-fill Fuel system
- Front fenders
- Inline filters, steering and hydraulic
- Integrated load meter
- Jumpstart Receptacle
- KOMTRAX® with KOMTRAX PLUS® function and ground level download port
- Lift cylinders and bucket cylinder
- Lock-up clutch torque converter
- Modulation clutch
- Powertrain Underguard
- Rear access stair with handrail, RH side.
- Remote boom positioner, in-cab adjustable
- Remote bucket positioner, in-cab adjustable, three positions
- Service centre for Engine, Hydraulic, Transmission Oils (EVAC System).
- Transmission speed ranges, 4 forward and 4 reverse
- Vandalism protection kit
- Work equipment shock reduction control



## OPTIONAL EQUIPMENT

- 3850 mm boom
- 3-spool valve with lever and piping
- Additional Lighting
- Bluetooth AM/FM Radio
- Broadband reverse alarm
- Fire extinguishers
- Fire suppression systems
- Load-and-carry specification
- Rear Proximity/Reverse Sensors
- UHF Radio
- Various bucket options
- Weigh Scale system

WA600-8



W4600-8

[www.Komatsu.com.au](http://www.Komatsu.com.au)

Printed in Australia

**KOMATSU**<sup>®</sup>

Form No: ZESS004900\_MARCH2019

Materials and specifications are subject to change without notice.  
**KOMATSU** is a trademark of Komatsu Ltd. Japan.