

# KOMATSU

## WA500-7

Australian New Zealand Specification

**HORSEPOWER**  
Gross: 266 kW 357 HP / 1900 min<sup>-1</sup>  
Net: 263 kW 353 HP / 1900 min<sup>-1</sup>

**BUCKET CAPACITY**  
3.8–4.65 m<sup>3</sup>

**WA**  
**500**

W  
H  
E  
E  
L  
L  
O  
A  
D  
E  
R



# WALK-AROUND

## ***High Productivity & Low Fuel Consumption***

- Komatsu's new engine technology
- Low fuel consumption
- Komatsu SmartLoader Logic
- Large-capacity torque converter
- Enhanced lock-up
- Dual-mode engine power select system
- ECO Guidance
- Variable displacement piston pump & Closed-center load sensing system (CLSS)
- Komatsu auto idle shutdown

See pages 4 and 5.

## ***Excellent Operator Environment***

- Ergonomic comfort
- Operator seat with Electronic Pilot Control levers
- Automatic kick-down
- Remote bucket & boom positioner
- Auxiliary input jack
- Equipped with 12 V outlet
- Low noise design
- Rear view monitoring system
- Seat belt caution indicator
- Engine shutdown secondary switch

See pages 6 and 7.



## **KOMTRAX®**

KOMTRAX equipped machines can send location, Service Meter Readings (SMR) and operation maps to a secure website utilising wireless technology. Machines also relay error codes, cautions, maintenance items, fuel levels, and much more.

## ***Environmentally Friendly***

- U.S. EPA Tier 4 Interim and EU Stage 3B emissions certified.
- Low fuel consumption

**Information & Communication Technology**

- Machine monitor
- Liquid Crystal Display (LCD) unit
- Fuel management by KOMTRAX
- Energy-saving operation support report

See page 8.

**HORSEPOWER**

Gross: 266 kW 357 HP / 1900 min<sup>-1</sup>

Net: 263 kW 353 HP / 1900 min<sup>-1</sup>

**BUCKET CAPACITY**

5.6 – 7.0 m<sup>3</sup>

**Easy Maintenance**

- Side-opening gull-wing engine doors
- Swing-out type cooling fan for wider core radiator

See page 9.

- Auto reversing fan
- Komatsu Diesel Particulate Filter (KDPF) regeneration
- Maintenance function
- Turbo II Pre Cleaner
- Rear Fenders
- Autogrease System

## HIGH PRODUCTIVITY & LOW FUEL CONSUMPTION

### High Performance Komatsu SAA6D140E-6 Engine

This engine delivers faster acceleration and higher travel speeds with high horsepower per ton in its class. Advanced technologies, such as Variable Geometry Turbocharger (VGT), KDPF, and High Pressure Common Rail (HPCR) enable the engine to meet U.S. EPA Tier 4 Interim and EU Stage 3B emissions certification. High torque at low speed, excellent acceleration, and low fuel consumption ensure maximum productivity.

### Komatsu's New Engine Technology

#### Newly Designed VGT

The newly designed variable geometry turbocharger features Komatsu proprietary technology that changes the air-flow and delivers air in optimum quantity to the engine

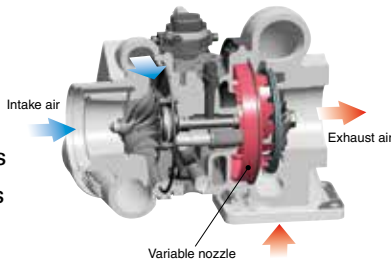

combustion chamber under all speed and load conditions. The result is cleaner exhaust gas and improved fuel economy while maintaining power and performance.

#### Newly Designed KDPF

Komatsu has designed and developed a high efficiency diesel particulate filter that captures more than 90% of Particulate Matter (PM). Passive and active regeneration is initiated automatically by the engine controller as needed to burn the particulates while the engine is running allowing uninterrupted machine operation. A special oxidation catalyst with fuel injection system eliminates the need for a traditional fuel burner thereby reducing maintenance costs and increasing reliability.

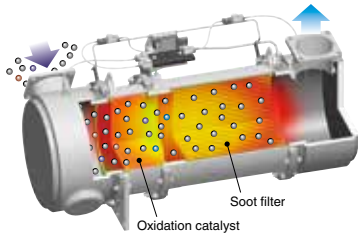

#### HPCR Fuel Injection System

Computer controlled HPCR system delivers pressurized fuel in precise quantity into the engine combustion chamber using multiple injections to achieve complete fuel burn and reduce exhaust emissions. Fuel injector life has been improved through the use of ultra-hard wear-resistant material such as diamond-like carbon.

#### Larger More Robust Cooled Exhaust Gas Recirculation (EGR) System

Cooled EGR, a technology well-proven in existing Komatsu engines, has increased capacity to further reduce NOx to Tier 4 levels. Larger more robust components ensure reliable performance during the demanding work conditions of the vehicle.

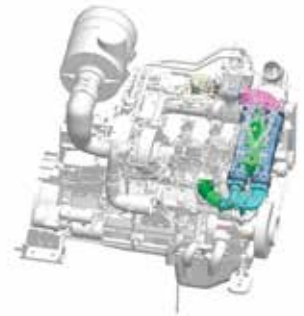

#### Redesigned Combustion Chamber

The fuel/air combustion chamber located at the top of the engine piston has a new shape designed to improve combustion and further reduce NOx, PM, fuel consumption and noise.

#### Komatsu Closed Crankcase Ventilation (KCCV)

Oil mist trap efficiency is significantly increased compared to the previous "Breather"s, from around 50% trap efficiency to 95% trap efficiency. Crankcase gas (blow-by gas) is fed back to the intake with reduced oil mist.

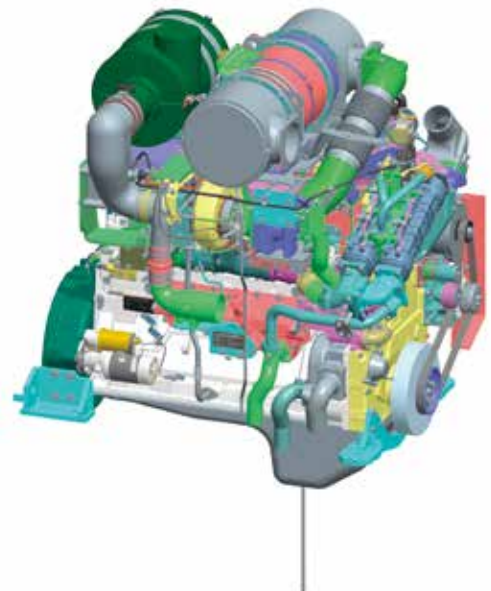

**Low Fuel Consumption**

Komatsu installed new features on the WA500-7 to reduce fuel consumption through enhancing fuel efficiency by optimally controlling engine power, realizing high efficiency power train and hydraulic system.

**Reduced by 7% Fuel consumption**

\* Compared with the WA500-6, fuel consumption varies depending on working conditions.

**Komatsu SmartLoader Logic**

The WA500-7 provides Komatsu SmartLoader Logic, a new engine control system. This technology acquires data from various sensors in the vehicle and controls the engine to yield enough torque for each work phase. Engine torque requirement for a wheel loader varies depending on working conditions. For example, it requires higher torque for digging in V-shape loading, but less torque in driving with an empty bucket. This technology limits the engine torque during less demanding work, therefore saving fuel. Komatsu SmartLoader Logic functions automatically and doesn't interfere with operation, saving fuel without decreasing production.

**Large-capacity Torque Converter**

The power train has a large capacity torque converter for optimum efficiency. WA500-7 has greater productivity in V-shape loading applications because of the increased tractive effort without requiring full throttle. The hill climbing ability allows the WA500-7 to up-shift gears faster because of improved acceleration. WA500-7 can achieve higher gear ranges and maintain higher travel speed when working in load-and-carry applications. In most applications, production is increased and fuel consumption reduced, resulting in improved fuel efficiency.

**Enhanced Lock-up**

Large-capacity torque converter with lock-up is standard on the WA500-7, and the lock-up function activates in 2nd, 3rd and 4th gears. The large capacity torque converter with the enhanced lock-up is effective for both load and carry application, and V-shape loading which uses lower gears. The enhanced lock-up reduces the clutch engagement shock by controlling engine torque with Komatsu SmartLoader Logic. Lower fuel consumption in load-and-carry applications, and V-shape loading results from the enhanced lock-up + Komatsu SmartLoader Logic.

**Dual-mode Engine Power Select System**

This wheel loader offers two selectable operating modes — E and P.

- **E Mode:** This mode provides maximum fuel efficiency for general loading.
- **P Mode:** This mode provides maximum power output for hard digging operation or hill climb.



Dual mode engine power selection switch

**ECO Guidance**

The ECO Guidance provides information on a monitor to help save fuel. The monitor displays messages in real-time during operation and on the exit screen when turning of the key. This function can be controlled through on the monitor.

The operator can view fuel consumption through the monitor as well as through KOMTRAX.

During operation



User menu for ON/OFF setting



Key OFF



**Variable Displacement Piston Pump & CLSS**

The variable displacement piston pump combined with the CLSS delivers hydraulic flow just as the job requires preventing wasted hydraulic flow. Minimized loss contributes to better fuel economy.

**Komatsu Auto Idle Shutdown**

Komatsu auto idle shutdown helps reduce idle time and reduce operating costs.



# EXCELLENT OPERATOR ENVIRONMENT



## Ergonomic Comfort

Ergonomically designed round dashboard is incorporated. Switches are arranged for easy access.

### Machine Monitor



### Color Rear View Monitor



### Multi-switch Panel



**Operator Seat with Electronic Pilot Control Levers**

The Electronic Pilot Control lever console is integrated in the seat and moves with it. The angle of the armrest is fully adjustable for optimum operator comfort.



**Low Noise Design**

Operator's ear noise level (ISO 6396:2008): 73 dB(A)  
 Dynamic noise level (outside) (ISO 6395:2008): 111 dB(A)

The large cab is mounted with Komatsu's unique ROPS/FOPS viscous mounts. The low-noise engine, hydraulically driven fan, and hydraulic pumps are mounted with rubber cushions, and the cab sealing is improved to provide a quiet, low-vibration, dustproof, and comfortable operating environment.



**Automatic Kick-down**

The WA500-7 has the function to shift down to F1 automatically. It can be controlled ON/OFF through the monitor.



**Rear View Monitoring System**

The operator can view the rear of the machine with a color monitor screen.



**Remote Bucket & Boom Positioner**

The operator can set bucket angle and remote boom positioner from the cab. Boom position is adjustable in the cab. Bucket positioner can memorize three horizontal settings. In each horizontal setting, the operator can adjust setting with the switch in the cab.



**Seat Belt Caution Indicator**

Lights up when seat belt is not used.



**Auxiliary Input Jack**

Connecting a regular audio instrument to the auxiliary jack allows the operator to listen the sound from the speaker installed in the cab.

**Equipped with 12 V Outlet**

In addition to 24 V cigarette lighter, two 12 V outlets are provided in the cab.

**Engine Shutdown Secondary Switch**

The engine stop switch is incorporated to allow shutdown of the machine when accessing the key switch is not possible.

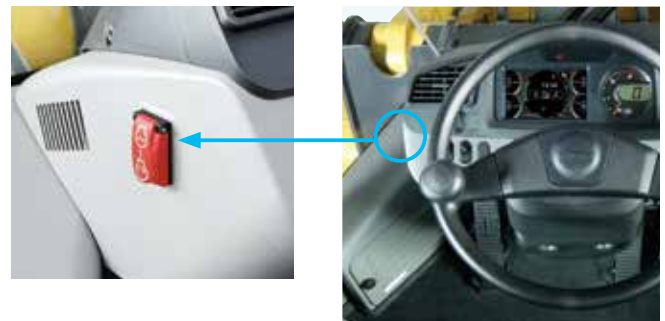

# INFORMATION & COMMUNICATION TECHNOLOGY

## Machine Monitor

The machine monitor display various machine information and allows for various settings of the machine. The LCD monitor is a 7-inch color LCD and displays maintenance information, operation record, ECO Guidance record, etc. The switch panel is used to select various screens and the air conditioner control screen. By using the switch panel, you can display various user menus on the LCD screen and adjust the machine settings.

### Machine monitor

- |                           |                                    |
|---------------------------|------------------------------------|
| ① LCD unit                | ⑧ Engine coolant temperature gauge |
| ② LED unit                | ⑨ Hydraulic oil temperature gauge  |
| ③ Engine tachometer       | ⑩ Torque converter oil temperature |
| ④ Speedometer             | ⑪ gauge                            |
| ⑤ ECO gauge               | ⑫ Fuel gauge                       |
| ⑥ Air conditioner display | ⑬ Message pilot lamp               |
| ⑦ Shift indicator         | Pilot lamps                        |



### Switch panel

- ① Air conditioner switches / Numerial key pad    ② Function switches

## LCD Unit

The LCD unit displays various information of the machine such as ECO Guidance, operation records, and maintenance information. Since the LCD unit has wider display area compared to that of conventional model and uses color LCD, it displays more information and is easy to read. For example, "Operation Records" menu displays various records of the actual working hours, average fuel consumption, idling hours, and E mode operation ratio, etc. These records are displayed in the form of daily data and time period data.

# KOMTRAX

## Assists Customer's Equipment Management and Contributes to Fuel Cost Cutting

### Fuel Management by KOMTRAX

In addition to existing items, information to assist fuel saving is provided.

- Average fuel consumption logs
- KDPF information
- Odometer

### Energy-saving Operation Support Report

KOMTRAX provides various useful information which includes the energy-saving operation support report based on the operating information of your machine such as fuel consumption and idle time.



# EASY MAINTENANCE



## Side-opening Gull-wing Engine Doors

The large gull-wing type engine doors are operated with less power assisted by gas springs. The doors open in two steps. The first position is for daily maintenance and the second position is for periodic maintenance. Large steps are provided on each side of the engine to help access.



## Swing-out Type Cooling Fan for Wider Core Radiator

The fan drive unit swings open for cleaning. It features wider spacing of cooling fins to prevent clogging. Wide core radiator can reduce core clogging.



## Rear Fenders

Fitted standard to the WA500-7 the rear fenders reduce the kick-up of debris and can be folded out of the way to allow easy access to the engine compartment for daily checks and Maintenance tasks.



## Auto Reversing Fan

The engine cooling fan is driven hydraulically. It can be set to operate in reverse automatically. Fan reverse mode can be controlled through the monitor.



## KDPF Regeneration

Soot trapped by and accumulated in the KDPF is removed by burning it periodically and automatically.

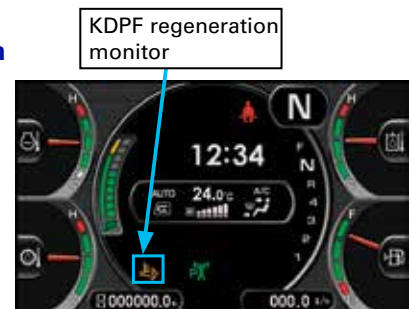

## Maintenance Function

The monitor informs when the replacement interval for oil and filters is reached.



# SPECIFICATIONS



## ENGINE

Model ..... Komatsu SAA6D140E-6  
 Type ..... Water-cooled, 4-cycle  
 Aspiration ..... Turbocharged, aftercooled, cooled EGR  
 Number of cylinders ..... 6  
 Bore x stroke ..... 140 mm x 165 mm  
 Piston displacement ..... 15.24 L  
 Governor ..... All-speed, electronic  
 Horsepower  
 SAE J1995 ..... Gross 266 kW 357 HP  
 ISO 9249/SAE J1349\* ..... Net 263 kW 353 HP  
 Rated rpm ..... 1900 min<sup>-1</sup>  
 Fan drive method for radiator cooling ..... Hydraulic  
 Fuel system ..... Direct injection  
 Lubrication system:  
 Method ..... Gear pump, force-lubrication  
 Filter ..... Full-flow type  
 Air cleaner ..... Dry type with double elements and dust evacuator, plus dust

indicator

\*Net horsepower at the maximum speed of radiator cooling fan is 250 kW 335 HP.

U.S. EPA Tier 4 Interim and EU Stage 3B emissions certified.



## TRANSMISSION

Torque converter:  
 Type ..... 3-element, 1-stage, 2-phase  
 Transmission:  
 Type ..... Automatic full-powershift, countershaft type  
 Travel speed: km/h  
 Measured with 29.5-R25 tires ( ) : Lock-up clutch ON

	1st	2nd	3rd	4th
Forward	7.5	12.9 (13.1)	22.2 (23.7)	35.5 (37.3)
Reverse	8.5	12.9 (13.0)	24.7 (26.6)	38.0 (38.0)

\* P Mode



## AXLES AND FINAL DRIVES

Drive system ..... Four-wheel drive  
 Front ..... Fixed, semi-floating  
 Rear ..... Center-pin support, semi-floating,  
 24° total oscillation  
 Reduction gear ..... Spiral bevel gear  
 Differential gear ..... Conventional type  
 Final reduction gear ..... Planetary gear, single reduction



## BRAKES

Service brakes ..... Hydraulically actuated,  
 wet multiple-disc brakes actuate on four wheels  
 Parking brake ..... Wet multiple-disc brake  
 Secondary brake ..... Parking brake is commonly used



## STEERING SYSTEM

Type ..... Articulated type, full-hydraulic power steering  
 Steering angle ..... 36° each direction (40° end stop)  
 Minimum turning radius at the center of outside tire ..... 7050 mm



## HYDRAULIC SYSTEM

Steering system:  
 Hydraulic pump ..... Piston pump  
 Capacity ..... 120 L/min  
 Relief valve setting ..... 24.5 MPa 250 kg/cm<sup>2</sup>  
 Hydraulic cylinders:  
 Type ..... Double-acting, piston type  
 Number of cylinders ..... 2  
 Bore x stroke ..... 100 mm x 486 mm

Loader control:  
 Hydraulic pump ..... Piston pump  
 Capacity ..... 320 L/min  
 Relief valve setting ..... 34.3 MPa 350 kg/cm<sup>2</sup>  
 Hydraulic cylinders:  
 Type ..... Double-acting, piston type  
 Number of cylinders—bore x stroke:  
 Lift cylinder ..... 2- 160 mm x 898 mm  
 Bucket cylinder ..... 1- 185 mm x 675 mm  
 Control valve ..... 2-spool type  
 Control positions:  
 Boom ..... Raise, hold, lower, and float  
 Bucket ..... Tilt-back, hold, and dump  
 Hydraulic cycle time (rated load in bucket)  
 Raise ..... 7.2 s  
 Dump ..... 1.7 s  
 Lower (Empty) ..... 4.2 s



## SERVICE REFILL CAPACITIES

Cooling system ..... 133 L  
 Fuel tank ..... 473 L  
 Engine ..... 37 L  
 Hydraulic system ..... 337 L  
 Axle front ..... 95 L  
 rear ..... 95 L  
 Torque converter and transmission ..... 71 L



## BUCKET SELECTION GUIDE

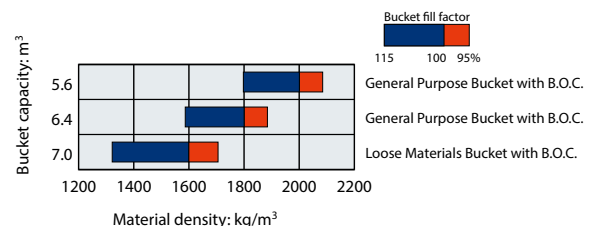



## DIMENSIONS

Measured with 29.5-R25 LS VSDL tires, ROPS/FOPS cab

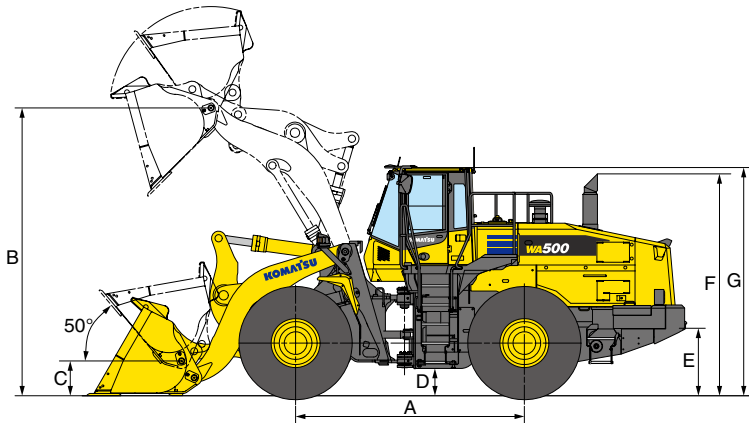

	Tread	2400 mm
	Width over tires	3190 mm
A	Wheelbase	3780 mm
B	Hinge pin height, max. height, standard boom	4755 mm
C	Hinge pin height, carry position	575 mm
D	Ground clearance	450 mm
E	Hitch height	1115 mm
F	Overall height, top of the stack	3665 mm
G	Overall height, ROPS cab	3785 mm

		Standard boom		
		General Purpose Bucket	General Purpose Bucket	Loose Material Bucket
		KGA Straight edge Bolt on Cutting Edge	KGA Straight edge Bolt on Cutting Edge	KGA Straight edge Bolt on Cutting Edge
Bucket capacity:	heaped	5.6 m <sup>3</sup>	6.4 m <sup>3</sup>	7.0 m <sup>3</sup>
	struck	4.9 m <sup>3</sup>	5.6 m <sup>3</sup>	6.1 m <sup>3</sup>
Bucket width		3400 mm	3400 mm	3510 mm
Bucket weight		3700 kg	3860 kg	4170 kg
Dumping clearance, max. height and 45° dump angle*		3315 mm	3235 mm	3185 mm
Reach at max. height and 45° dump angle*		1530 mm	1600 mm	1655 mm
Operating height (fully raised)		6595 mm	6760 mm	6820 mm
Overall length		9955 mm	10055 mm	10130 mm
Loader clearance circle diameter (bucket at carry, outside corner of bucket)		16610 mm	16665 mm	16795 mm
Digging depth:	0°	135 mm	135 mm	135 mm
	10°	440 mm	460 mm	470 mm
Static tipping load:	straight	28320 kg	28035 kg	27605 kg
	40° full turn	25160 kg	24885 kg	24465 kg
Breakout force		281 kN 28600 kg	267 kN 27200 kg	257 kN 26200 kg
Operating weight		37255 kg	37415 kg	37725 kg

\* At the end of tooth or bolt on cutting edge (B.O.C.).

All dimensions, weights, and performance values based on ISO 7131 and ISO 7546 standards.

Static tipping load and operating weight shown include lubricant, coolant, full fuel tank, ROPS cab, and operator. Machine stability and operating weight affected by counterweight, tire size, and other attachments.

Apply the following weight changes to operating weight and static tipping load.



## STANDARD EQUIPMENT

### ENGINE:

- Alternator, 24 V/90 A
- Batteries, 2 x 12 V/160 Ah
- Engine, Komatsu SAA6D140E-6
- KDPF (Diesel Particulate Filter)
- Starting motor, 24 V/11.0 kW

### CAB:

- 2 x DC12V electrical outlets
- Auto air conditioner
- AM/FM radio with AUX input jack
- Ashtray
- Cigarette lighter
- Color multi-monitor
- Cup holder
- Floor mat
- Front wiper (with washer and intermittent)
- Rear defroster (electric)
- Rear window washer and wiper
- ROPS/FOPS (ISO 3471/ISO 3449) cab
- Seat, air suspension with automatic weight adjustment
- Seat belt
- Space for lunch box
- Steering wheel, tiltable, telescopic
- Sun visor

### LIGHTING SYSTEM:

- Back-up lamps, LED
- Directional signal
- Hazard lamps
- Rear work lamps, LH and RH side
- Stop and tail lamps, LED and turn signal lamps

### SAFETY EQUIPMENT:

- Back-up alarm
- Engine shutdown secondary switch
- Hand rails for platform
- Horn, electric
- Parking brake
- Rear view monitoring system
- Service brakes, wet disc type
- 3x ESTOPS (1x Cab, 2x Rear)
- Secondary steering (ISO 5010)

### TIRES:

- 29.5R25 (BS L5 VSDL \*\*)

### OTHER:

- 2-spool valve for boom and bucket controls
- Auto idle shutdown
- Auto shift transmission with mode select system
- Lockable Battery Isolator

- Automatic Greasing system
- Counterweight, Logging
- Additional counterweight (900kg)
- Power train guard
- ECO Guidance
- Electronically Controlled Suspension system
- Equipment Management Monitoring system
- Engine shut-off system, electric
- Electronic Pilot Control fingertip control levers with automatic leveler and positioner
- Front fender
- Full fear fenders
- Fuel pre-filter with water separator
- Hydraulic-driven fan with reverse rotation
- KOMTRAX
- Lift cylinders and bucket cylinder
- Loader linkage with standard boom
- Lock-up clutch torque converter
- Radiator mask, lattice type
- Remote boom positioner
- Remote bucket positioner
- Transmission, 4 forward and 4 reverse
- Vandalism protection kit
- Wide Coolers (excl. Condensor)



## OPTIONAL EQUIPMENT

### SAFETY EQUIPMENT:

- Fire Suppression system
- Fire Extinguishers
- Broadband Reverse Alarm
- Lockable starter isolation

### OTHER:

- Limited slip differential (F&R) Factory order only
- Bluetooth CD Radio AM/FM
- UHF/CB Radio

- Wiggins Fast Fuel
- Jump start receptacle
- LED Worklights
- LED Worklights
- Scales

**Australia** - Ph: 1300 566 287 | Web: [www.komatsu.com.au](http://www.komatsu.com.au)

**New Zealand** - Ph: 0800 566 2878 | Web: [www.komatsu.co.nz](http://www.komatsu.co.nz)

**New Caledonia** - Ph: +687 43 53 06

**Email** - [info@komatsu.com.au](mailto:info@komatsu.com.au)

# KOMATSU

*Driven by your success*

