

# KOMATSU

# PC138USLC-11

EPA Tier 4 Final Engine

Australia & New Zealand Specifications

HYDRAULIC EXCAVATOR



Photos may include optional equipment.

**NET HORSEPOWER**

72 kW / 97.2 HP @ 2050 rpm

**OPERATING WEIGHT**

15,492 – 15,852 kg

**BUCKET CAPACITY**

0.21 – 0.53 m<sup>3</sup>

PC138USLC

# WALK-AROUND

PC138USLG-11



Photos may include optional equipment.

## NET HORSEPOWER

72 kW / 97.2 HP @ 2050 rpm

## OPERATING WEIGHT

15,492 – 15,852 kg

## BUCKET CAPACITY

0.21 – 0.53 m<sup>3</sup>

## FUEL ECONOMY & TIGHT TAIL PERFORMANCE

**New engine and hydraulic control technology** improves operational efficiency and lower fuel consumption by up to 9%.

**Rounded cab profile** with a sliding door, allows the cab to swing within the same swing radius as the counterweight for true tight tail performance.

A powerful **Komatsu SAA4D95LE-7 engine** provides a net output of 72.5 kW 97.2 HP. This engine is EPA Tier 4 Final emissions certified.

**Variable Flow Turbocharger** improves engine response and provides optimum air flow under all speed and load conditions.

**Komatsu Diesel Oxidation Catalyst (KDOC)** reduces particulate matter using passive regeneration over **98% of the time**.

**Selective Catalytic Reduction (SCR)** reduces NOx and has easy to access components.

**Enhanced working modes** are designed to match engine speed, pump delivery, and system pressure to the application.

**Komatsu's Closed-centre Load Sensing System (CLSS)** provides quick response and smooth operation to maximise productivity.

**Temperature controlled fan clutch** helps improve fuel efficiency and lower sound levels.

The **KOMTRAX®** telematics system is standard on Komatsu equipment with no subscription-fee's throughout the life of the machine. Using the latest wireless technology, **KOMTRAX®** transmits valuable information such as location, utilisation, and maintenance records to a PC or smartphone app. Custom machine reports are provided for identifying machine efficiency and operating trends. **KOMTRAX®** also provides advanced machine troubleshooting capabilities by continuously monitoring machine health.

### Large LCD colour monitor panel:

- 7" high resolution screen
- Provides "Ecology-Guidance" for fuel efficient operation
- Enhanced attachment control

### Rearview monitoring system (standard)

**Equipment Management Monitoring System (EMMS)** continuously monitors machine operation and vital systems to identify machine issues and assist with troubleshooting.



### Enhanced working environment

- Integrated ROPS cab design (ISO 12117-2)
- Cab meets ISO Level 1 Operator Protective Guard (OPG) top guard (ISO 10262)
- Aux jack and (2) 12V outlets

### Komatsu designed and manufactured components

**Wide access service doors** provide easy access for ground level maintenance.

**New quick return arm valve** improves arm cylinder hydraulic flow for faster arm out speed and performance.

**Handrails (standard)** provides convenient access to the upper structure.

**Lockable single pole battery isolation switch** allows a technician to disconnect the power supply before servicing the machine.

**Komatsu Auto Idle Shutdown** helps reduce nonproductive engine idle time and reduces operating costs.

**Operational Identification System** can track machine operation for up to 100 operators.

# PERFORMANCE FEATURES

## KOMATSU NEW ENGINE TECHNOLOGIES

### New Tier 4 Final Engine

The Komatsu SAA4D95LE-7 engine is EPA Tier 4 Final emissions certified and provides exceptional performance while reducing fuel consumption. Based on Komatsu proprietary technologies developed over many years, this new diesel engine reduces particulate matter (PM) and nitrogen oxides (NOx) by more than 90% when compared to Tier 3 levels. Through the in-house development and production of engines, electronics, and hydraulic components, Komatsu has achieved great advancements in technology, providing high levels of performance and efficiency in virtually all applications.

### Technologies Applied to New Engine

#### Heavy-duty aftertreatment system

This new system combines a Komatsu Diesel Oxidation Catalyst (KDOC) and SCR. The SCR NOx reduction system injects the correct amount of Diesel Exhaust Fluid (DEF) at the proper rate, thereby decomposing NOx into non-toxic water (H<sub>2</sub>O) and nitrogen gas (N<sub>2</sub>).

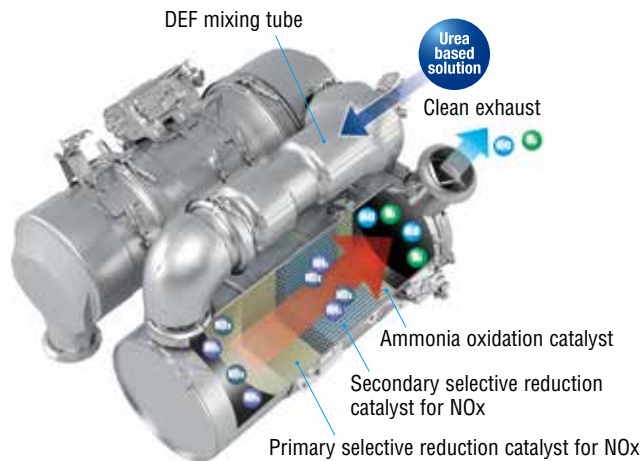

#### Variable flow turbocharger

A variable flow turbocharger features simple and reliable technology that varies the intake air-flow. The Exhaust turbine speed is controlled by a flow control valve that optimises air volume to the engine combustion chamber under all engine speed and load conditions. The result is cleaner exhaust gas while maintaining power and performance.

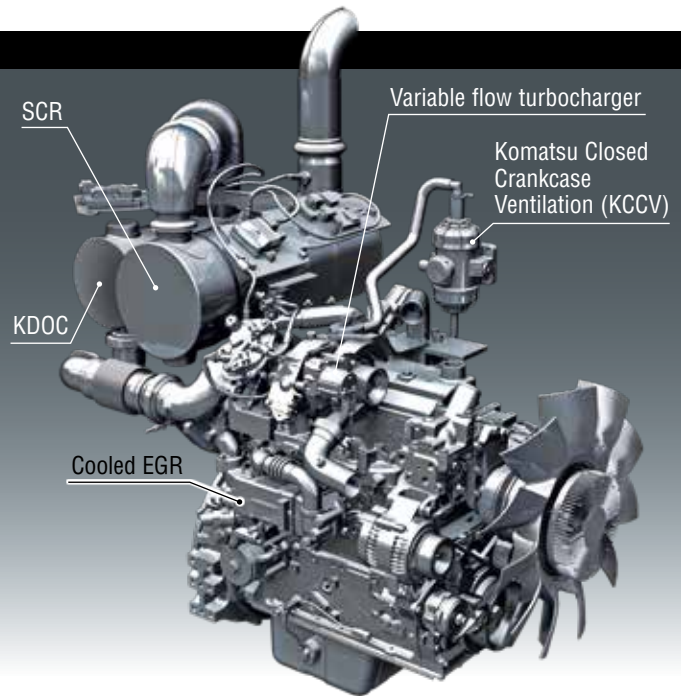
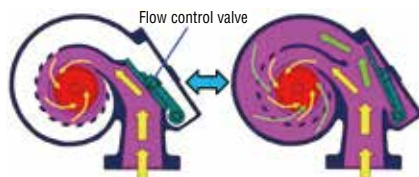

#### Heavy-duty cooled Exhaust Gas Recirculation (EGR) system

The system recirculates a portion of exhaust gas into air intake and lowers combustion temperatures to reduce NOx emissions. Furthermore, while EGR gas flow is increased, by incorporating a high-efficiency and compactly designed cooling system, the system achieves a dynamic reduction of NOx, while helping reduce fuel consumption.

#### Advanced Electronic control system

The electronic control system performs high-speed processing of all signals from sensors installed in the machine providing total control of equipment in all operating conditions of use. Engine condition information is displayed via an onboard network to the monitor inside the cab, providing necessary information to the operator. Additionally, managing the information via KOMTRAX helps customers keep up with required maintenance.

#### High Pressure Common Rail (HPCR) fuel injection system

High pressure fuel injection with computerised control attains close to complete combustion reducing Particulate Matter (PM) emissions. While this technology is already used in current engines, the new system uses a higher-pressure injection, thereby reducing both PM emissions and fuel consumption at all engine load conditions.

PG138USLG-11

## Reduced Fuel Consumption

Fuel consumption is reduced up to 9% using a temperature controlled viscous fan clutch and improved engine and hydraulic system efficiencies.

### Fuel Consumption

## Reduced by up to 9%

(vs PC138US-8 Based on typical work pattern collected via KOMTRAX)

This fuel consumption data is the result compared actual measured value using the prototype machine. Actual fuel savings may vary depending on application and operating conditions.

## Komatsu Auto Idle Shutdown

Komatsu auto idle shutdown automatically shuts the engine down after idling for a set period of time to reduce unnecessary fuel consumption and exhaust emissions.

## Viscous fan clutch

Reduces engine loads at lower operating temperatures.

## Arm quick return valve

When the arm is extended, the quick return valve directs additional oil through a second line directly back to tank which reduces back pressure. Reduces fuel consumption and improves efficiency.

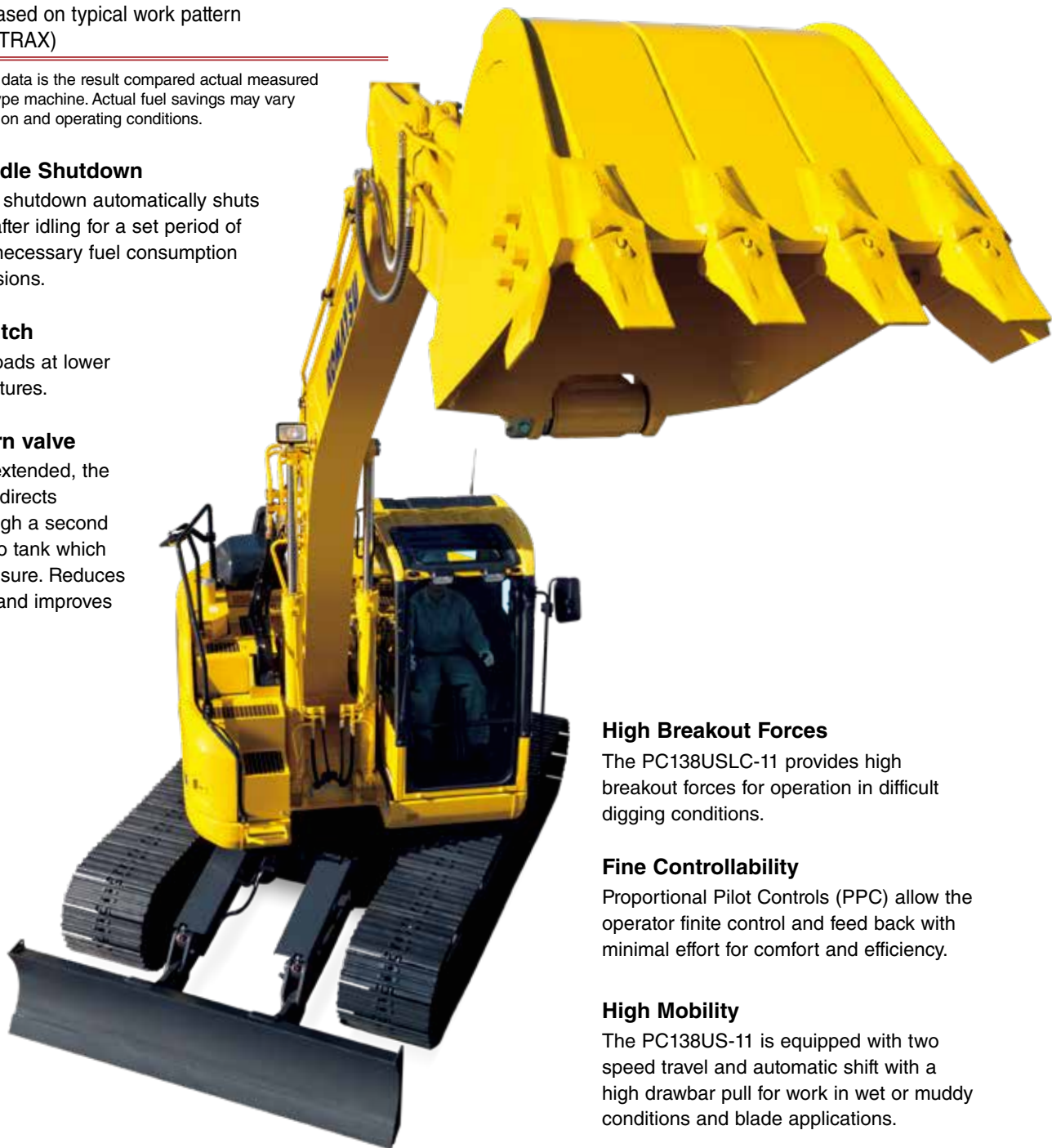

## High Breakout Forces

The PC138USLC-11 provides high breakout forces for operation in difficult digging conditions.

## Fine Controllability

Proportional Pilot Controls (PPC) allow the operator finite control and feed back with minimal effort for comfort and efficiency.

## High Mobility

The PC138US-11 is equipped with two speed travel and automatic shift with a high drawbar pull for work in wet or muddy conditions and blade applications.

# PERFORMANCE FEATURES

PC138USLC-11

## Efficient Hydraulic System

The PC138USLC-11 uses a Closed-centre Load Sensing System (CLSS) that improves fuel efficiency and provides quick response to the operator's demands. The control system matches engine and hydraulic demand at the most efficient point under any load condition. There have also been improvements in the main valve and hydraulic circuit to reduce hydraulic loss, resulting in higher efficiency and lower fuel consumption.

## Large Displacement High Efficiency Pump

Large displacement hydraulic implement pumps provide high flow output at lower engine RPM as well as operation at the most efficient engine speed.



## Working Mode Selection

The PC138USLC-11 excavator is equipped with six working modes (P, E, L, B, ATT/P and ATT/E). Each mode is designed to match engine speed, pump flow, and system pressure to the application. The PC138USLC-11 features an attachment mode (ATT/E) that allows operators to run attachments while in Economy mode.

Working Mode	Application	Advantage
<b>P</b>	Power mode	<ul style="list-style-type: none"> <li>•Maximum production/power</li> <li>•Fast cycle times</li> </ul>
<b>E</b>	Economy mode	<ul style="list-style-type: none"> <li>•Good cycle times</li> <li>•Better fuel economy</li> </ul>
<b>L</b>	Lifting mode	<ul style="list-style-type: none"> <li>•Increases hydraulic pressure</li> </ul>
<b>B</b>	Breaker mode	<ul style="list-style-type: none"> <li>•Optimum engine rpm, hydraulic flow</li> </ul>
<b>ATT/P</b>	Attachment Power mode	<ul style="list-style-type: none"> <li>•Optimum engine rpm, hydraulic flow, 2-way</li> <li>•Power mode</li> </ul>
<b>ATT/E</b>	Attachment Economy mode	<ul style="list-style-type: none"> <li>•Optimum engine rpm, hydraulic flow, 2-way</li> <li>•Economy mode</li> </ul>

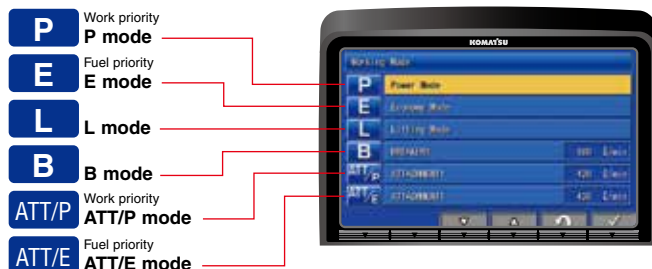

## High Rigidity Work Equipment

Booms and arms are constructed with thick plates of high tensile strength steel. In addition, these structures are designed with large cross sectional areas and large one piece steel castings in the boom foot, the boom tip, and the arm tip. The result is work equipment that exhibits long term durability and high resistance to bending and torsional stress.



# OPERATIONAL FEATURES

## SHORT SWING RADIUS

### Short Implement Swing Radius

A higher boom raise angle than a standard excavator reduces the minimum front implement swing radius down to 1980mm. The result is greater front swing clearance when space is limited.

### Short Tail Swing Radius

1480 mm short tail swing radius of the PC138USLC-11 allows the machine to work in more confined areas than a conventional machine.

### Ideal for Confined Applications

The PC138USLC-11 is an ideal machine for applications such as road work, underground utilities or other applications where a conventional excavator will not fit. The contoured cab design and convex sliding door allow the cab to swing within the same radius as the counterweight. Trucks can be positioned closer to the machine when working within one lane of traffic, improving operator confidence and job efficiency.

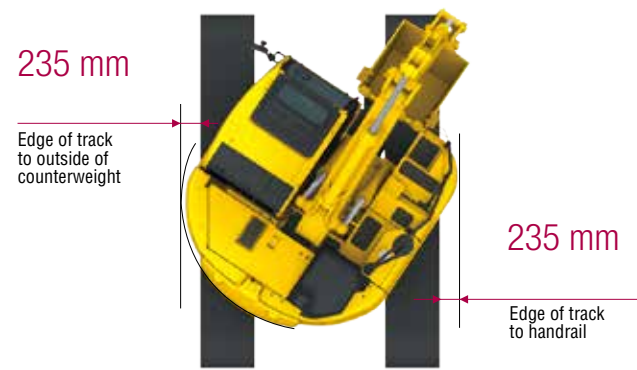
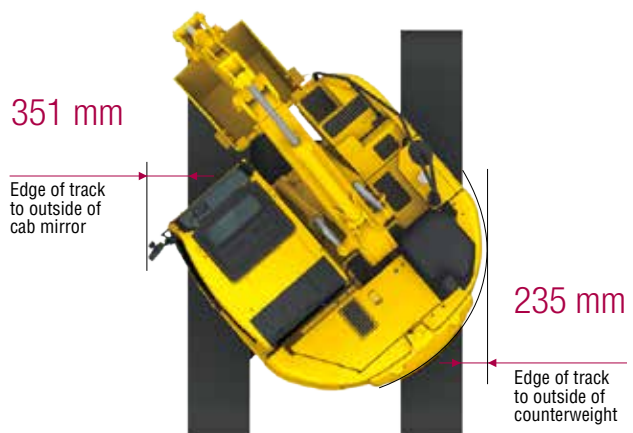

Shoe width is 500 mm

# WORKING ENVIRONMENT

PG138USLG-11





**Comfortable Working Space**

**Large cab with wide front view and foot space**

A large operator cab with rounded corner provides an overall cab size similar to a standard excavator cab even though this machine has an extra small swing radius. A sliding door enables easy access especially in confined work areas. Additional operator comfort is provided with a fully adjustable suspension seat.

**Automatic Air Conditioner**

The automatic air conditioner allows the operator to easily and precisely set the cab atmosphere using the large LCD colour monitor panel. The bi-level control function improves air flow and keeps the inside of the cab comfortable throughout the year.



**Pressurised Cab**

**Low vibration with cab damper mounting**

**Low cab noise**

**Auxiliary input jack**

Connecting an auxiliary device such as an MP3 player to the auxiliary input enables the operator to hear the sound throughout the stereo speakers installed in the cab.



**Standard Equipment**

**AM/FM radio**



**Cup holder**



**Remote intermittent wiper with windshield washer**



**Emergency stop and level indicator**



**ISO Level 2 OPG**



**Literature box**



**Defroster (conforms to the ISO standard)**



**Pull-up front window**



# WORKING ENVIRONMENT

## LARGE HIGH RESOLUTION LIQUID CRYSTAL DISPLAY (LCD) MONITOR



### New Monitor Panel Interface Design

An updated large high resolution LCD colour monitor enables accurate and smooth work. The interface has been redesigned to display key machine information in a new user friendly interface. A rear view camera and a DEF level gauge display have been added to the default main screen. The interface has a function that enables the main screen mode to be changed to provide the optimum screen information for the operator.

#### Indicators

- |                                    |                             |
|------------------------------------|-----------------------------|
| 1 Auto-decelerator                 | 8 Fuel gauge                |
| 2 Working mode                     | 9 DEF level gauge           |
| 3 Travel speed                     | 10 Service metre, clock     |
| 4 Ecology gauge                    | 11 Fuel consumption gauge   |
| 5 Camera display                   | 12 Guidance icon            |
| 6 Engine coolant temperature gauge | 13 Function switches        |
| 7 Hydraulic oil temperature gauge  | 14 Camera direction display |
|                                    | 15 DEF level caution lamp   |

#### Basic operation switches

- |                         |                         |
|-------------------------|-------------------------|
| 1 Auto-decelerator      | 4 Buzzer cancel         |
| 2 Working mode selector | 5 Wiper                 |
| 3 Travel speed selector | 6 Window washer         |
|                         | 7 Auto climate controls |

### Switchable display modes

The updated monitor screen display mode can be easily switched by pressing the F3 key.



### Visual user menu

Pressing the F6 key on the main screen displays the user menu screen. The menus are grouped for each function, and use easy-to-understand icons which enable the machine to be operated easily.



- |                                      |                    |
|--------------------------------------|--------------------|
| 1 Energy saving guidance             | 2 Machine settings |
| 3 Aftertreatment device regeneration | 4 SCR information  |
| 5 Maintenance                        | 6 Monitor setting  |
|                                      | 7 Message check    |

## Support Efficiency Improvement

### Ecology guidance

While the machine is operating, ecology guidance pops up on the monitor screen to notify the operator of the status of the machine in real time.

### Ecology gauge & fuel consumption gauge

The monitor screen is provided with an ecology gauge and also a fuel consumption gauge which is displayed continuously. In addition, the operator can set any desired target value of fuel consumption (within the range of the green display), enabling the machine to be operated with better fuel economy.



Ecology gauge      Fuel consumption gauge  
Ecology guidance

### Operator Identification Function

An operator identification ID can be set up for each operator, and used to manage operation information of individual machines using KOMTRAX data. Data sent from KOMTRAX can be used to analyse operation status by operator as well as by machine.



### Operation record, fuel consumption history, and ecology guidance record

The ecology guidance menu enables the operator to check the operation record, fuel consumption history and ecology guidance record from the ecology guidance menu, using a single touch, thus assisting operators with reducing total fuel consumption.

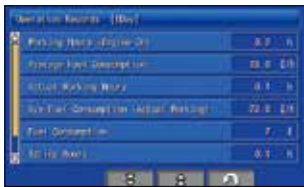

Operation record

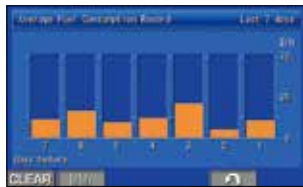

Fuel consumption history

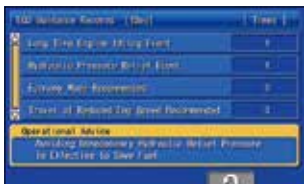

Ecology guidance record



# MAINTENANCE FEATURES

## Standard high-efficiency fuel filter and fuel pre-filter with water separator

A high-efficiency fuel filter and a fuel pre-filter with water separator increase reliability.



High efficiency fuel filter

Fuel pre-filter (With water separator)

## Battery isolation switch

A standard battery isolation switch allows a technician to disconnect the power supply and lock out before servicing the machine.



## Easy to access air conditioner filter

## Easy-to-clean cab floor mat

## Large tool box

## Fan belt auto-tensioner

## Side-by-side cooling

Easy access to engine oil filter, engine main fuel filter and fuel drain valve



## Long-life oils, filter

High performance filters are used in the hydraulic circuit and engine. By increasing the oil and filter replacement intervals, maintenance costs can be significantly reduced.

Engine oil & Engine oil filter	every 500 hours
Hydraulic oil	every 5000 hours
Hydraulic oil filter	every 1000 hours



Hydraulic oil filter  
(Ecology-white element)

## Attachment circuit filter

An easy access filter protects the hydraulic system from attachment contaminants.



## DEF tank and pump

Designed for ground level access, the DEF tank includes a sight glass gauge and the DEF pump and filter are conveniently located next to the DEF tank.



## Maintenance Information

### “Maintenance time caution lamp” display

When the remaining time to maintenance becomes less than 30 hours\*, a maintenance time monitor appears. Pressing the F6 key switches the monitor to the maintenance screen.

\* : The setting can be changed within the range between 10 and 200 hours.



Maintenance screen

### Aftertreatment device automatic regeneration display

When performing automatic regeneration to clean any urea deposits in the exhaust system, the monitor will display an action icon to the operator. There is no interruption to the operation of the machine during this cycle.



Aftertreatment device regeneration screen

### DEF level and refill timing

The DEF level gauge is displayed continuously on the right side of the monitor screen. In addition, when the DEF level is low, DEF low level guidance messages appear as pop up displays to inform the operator.

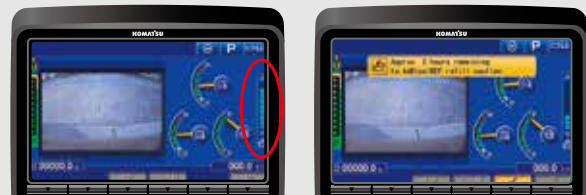

DEF level gauge

DEF low level guidance

## DT-type connectors

Sealed DT-type electrical connectors provide high reliability, water and dust resistance.

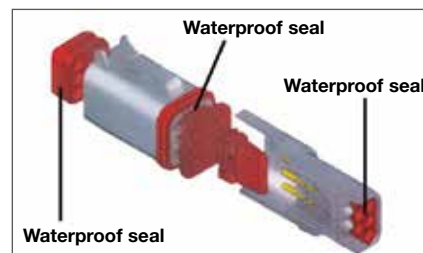

# GENERAL FEATURES

## ROPS CAB STRUCTURE

### ROPS Cab (ISO 12117-2)

The machine is equipped with a ROPS cab that conforms to ISO 12117-2 for excavators as standard equipment. It also satisfies the requirements for Level 1 Operator Protective Guard (OPG) and top guard (ISO 10262).



## Rear View Monitoring System

An updated rear view monitoring system display has a camera image that is continuously displayed together with the gauges and important vehicle information. This enables the operator to carry out work while easily checking the surrounding area.

Rear view camera



Rear view image on monitor



## Low Vibration with Viscous Cab Mounts

The PC138USLC-11 uses viscous mounts for the cab that incorporate a longer stroke and the addition of a spring. The cab damper mounting combined with a high rigidity deck reduces vibration at the operator's seat.

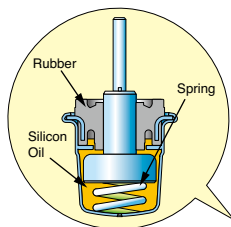

## GENERAL FEATURES

- Lock lever
- Seat belt, retractable
- Tempered & tinted glass
- Large mirrors
- Slip-resistant plates
- Thermal and fan guards
- Pump/engine room partition
- Travel alarm
- Large cab entrance step
- Handrails
- Sliding door

**Secondary engine shut down switch** at base of seat to shutdown the engine.



# KALSS AUSTRALIAN STANDARD SPECIFICATION



### Rotating Amber Beacon

Fitted with factory guard.



### Level Indicator, Overload Alarm & Anti-Burst Valves

Enable safety and compliance when lifting suspended loads.



### Additional Lighting

Extra lighting on cab for improved visibility.



### Proportional Hand Controls

Enables proportional hand control of attachment speed.

### Factory Fitted Quick Hitch and Hammer Piping

Enables use with a greater variety of attachments. Also fitted with provision for tilt circuit including valve.

### Reinforced Arm and Link

Reinforced steel plate to provide additional protection of arm structure and heavy duty links.



Image for illustrative purposes only. US model shown.

### Heavy Duty Revolving Frame Under Covers

Protects and prevents ingress of material into engine bay.



### Lower Front Window Guard

Protects cabin windscreen against rocks and debris.



### Battery Isolation

Single pole, lockable Bosch-type battery isolation.



### E-Stops

Allow compliance to site safety requirements.



### Bolt-on Top Guard

OPG level 2 (ISO 10262) for falling object protection.

Specification also includes factory fitted provisions for fire extinguisher, turbo timer, UHF and vandal covers to reduce lead times and costs. Photos may include optional equipment.

# SPECIFICATIONS



## ENGINE

Model ..... Komatsu SAA4D95LE-7\*  
 Type ..... Water-cooled, 4-cycle, direct injection  
 Aspiration ..... Variable flow, turbocharged, aftercooled, cooled EGR  
 Number of cylinders ..... 4  
 Bore ..... **95 mm** 3.74"  
 Stroke ..... **115 mm** 4.53"  
 Piston displacement ..... **3.26 ltr** 199 in<sup>3</sup>  
 Horsepower:  
 SAE J1995 ..... **Gross 72.6 kW** 97.3 HP  
 ISO 9249 / SAE J1349 ..... **Net 72.5 kW** 97.2 HP  
 Rated rpm ..... 2050  
 Fan drive method for radiator cooling ..... Mechanical with viscous clutch  
 Governor ..... All-speed control, electronic  
 \*EPA Tier 4 Final emissions certified



## HYDRAULICS

Type ..... HydrauMind (Hydraulic Mechanical Intelligence) system, closed-centre system with load sensing valve and pressure compensated valve  
 Number of selectable working modes ..... 6  
 Main pump:  
 Type ..... Variable capacity piston type  
 Pump for ..... Boom, arm, bucket, swing, and travel circuits  
 Maximum flow ..... **242 ltr/min** 64 gal/min  
 Hydraulic motors:  
 Travel ..... 2 x piston motor with parking brake  
 Swing ..... 1 x piston motor with swing holding brake  
 Relief valve setting:  
 Implement circuits ..... **34.8 MPa 355 kgf/cm<sup>2</sup>** 5,050 psi  
 Travel circuit ..... **34.8 MPa 355 kgf/cm<sup>2</sup>** 5,050 psi  
 Swing circuit ..... **29.2 MPa 298 kgf/cm<sup>2</sup>** 4,240 psi  
 Pilot circuit ..... **3.2 MPa 33 kgf/cm<sup>2</sup>** 470 psi  
 Hydraulic cylinders:  
 (Number of cylinders – bore x stroke x rod diameter)  
 Boom ..... **2–105 mm x 1055 mm x 70 mm** 4.1" x 41.5" x 2.76"  
 Arm ..... **1–110 mm x 1175 mm x 75 mm** 4.3" x 46.3" x 2.95"  
 Bucket ..... **1–95 mm x 885 mm x 65 mm** 3.7" x 34.8" x 2.56"



## DRIVES AND BRAKES

Steering control ..... Two levers with pedals  
 Drive method ..... Fully hydrostatic  
 Maximum drawbar pull ..... **123 kN 12500 kgf** 27,560 lbf  
 Gradeability ..... 70%, 35°  
 Maximum travel speed (auto-shift):  
 High ..... **5.1 km/h** 3.2 mph  
 Low ..... **2.9 km/h** 1.8 mph  
 Service brake ..... Hydraulic lock  
 Parking brake ..... Wet, multiple-disc



## SWING SYSTEM

Driven by ..... Hydraulic motor  
 Swing reduction ..... Planetary gear  
 Swing circle lubrication ..... Grease-bathed  
 Service brake ..... Hydraulic lock  
 Swing lock ..... Wet, multiple-disc brake  
 Swing speed ..... 11.0 rpm  
 Swing torque ..... **2991 kg•m** 21,627 ft lbs



## UNDERCARRIAGE

Centre frame ..... X-frame leg  
 Track frame ..... Box-section  
 Track type ..... Sealed track  
 Track adjuster ..... Hydraulic  
 Number of shoes (each side) ..... 46  
 Number of carrier rollers (each side) ..... 2  
 Number of track rollers (each side) ..... 8



## COOLANT & LUBRICANT CAPACITY (REFILLING)

Fuel tank ..... **200 ltr** 52.8 U.S. gal  
 Coolant ..... **17.7 ltr** 4.6 U.S. gal  
 Engine ..... **11.5 ltr** 3.0 U.S. gal  
 Final drive, each side ..... **2.1 ltr** .55 U.S. gal  
 Swing drive ..... **2.5 ltr** 0.7 U.S. gal  
 Hydraulic tank ..... **69.0 ltr** 18.2 U.S. gal  
 DEF tank ..... **12.6 ltr** 3.3 U.S. gal



## OPERATING WEIGHT (APPROXIMATE)

Operating weight includes **4600 mm** one-piece boom, **2500 mm** arm, rated capacity of lubricants, coolant, full fuel tank, operator, standard equipment, KGA dual lock quick hitch, and SAE heaped **0.53 m<sup>3</sup>** bucket.

Shoes	Operating Weight	Ground Pressure
Steel city pattern 500 mm	15,630 kg	0.47 kg/cm <sup>2</sup>
Rubber road liner 500 mm	15,710 kg	0.47 kg/cm <sup>2</sup>
Triple-grouser 500 mm	15,680 kg	0.47 kg/cm <sup>2</sup>
Triple-grouser 600 mm	16,030 kg	0.40 kg/cm <sup>2</sup>

### Component Weights:

Arm including bucket cylinder and linkage  
**2100 mm** arm assembly ..... **556 kg** 1,226 lb  
**2500 mm** arm assembly ..... **657 kg** 1,448 lb  
**3000 mm** arm assembly ..... **705 kg** 1,554 lb  
 One piece boom including arm cylinder:  
**4600 mm** boom assembly ..... **962 kg** 2,118 lb  
 Boom cylinders x 2 ..... **105 kg** 231 lb  
 Counterweight ..... **2640 kg** 5,820 lb  
 Blade ..... **800 kg** 1,764 lb



## DIMENSIONS

	Arm Length	2500 mm	2100 mm	3000 mm
A	Overall length	7385 mm	7275 mm	7160 mm
B	Overall height (to top of boom)*	2850 mm	2805 mm	2310 mm
C	Length on ground (transport)	4400 mm	4640 mm	4290 mm
D	Overall width	2490 mm		
E	Overall height (to top of cab)*	2815 mm		
F	Ground clearance, counterweight	900 mm		
G	Ground clearance, minimum	395 mm		
H	Tail swing radius	1480 mm		
I	Track length on ground	3140 mm		
J	Track length	3870 mm		
K	Track gauge	1990 mm		
L	Width of crawler	2490 mm		
M	Shoe width	500 mm		
N	Grouser height	20 mm		
O	Machine height to top of counterweight	2140 mm		
P	Machine upper width	2490 mm		
Q	Distance, swing centre to rear end	1480 mm		

\* : Including grouser height

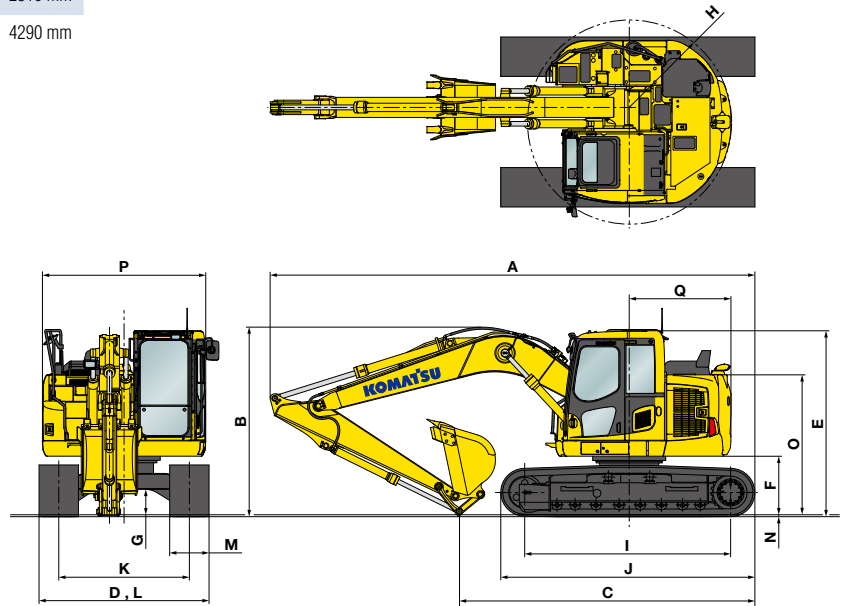

## WORKING RANGE

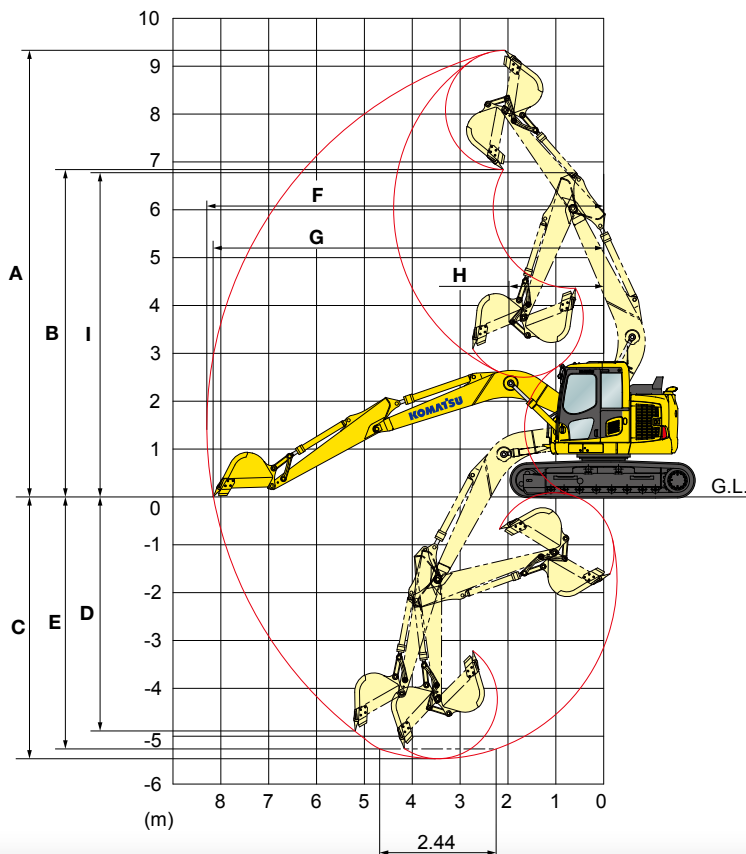

	Arm Length	2500 mm	2100 mm	3000 mm
A	Max. digging height	9340 mm	9020 mm	9700 mm
B	Max. dumping height	6840 mm	6525 mm	7350 mm
C	Max. digging depth	5480 mm	5070 mm	5900 mm
D	Max. vertical wall digging depth	4900 mm	4490 mm	5340 mm
E	Max. digging depth for 8° level bottom	5265 mm	4835 mm	5715 mm
F	Max. digging reach	8300 mm	7930 mm	8720 mm
G	Max. digging reach at ground level	8180 mm	7805 mm	8600 mm
H	Min. swing radius	1980 mm	1845 mm	2264 mm
I	Max. height at min. swing radius	6770 mm	6770 mm	6770 mm
SAE rating	Bucket digging force	81.4 kN 8300 kgf	81 kN 8250 kgf	78.0 kN 7950 kgf
	Arm crowd force	60.8 kN 6200 kgf	66 kN 6730 kgf	54.4 kN 5550 kgf
ISO rating	Bucket digging force	93.2 kN 9500 kgf	93 kN 9480 kgf	88.3 kN 9000 kgf
	Arm crowd force	61.8 kN 6300 kgf	70 kN 7130 kgf	55.9 kN 5700 kgf

# LIFT CAPACITIES



## LIFTING CAPACITY WITH LIFTING MODE

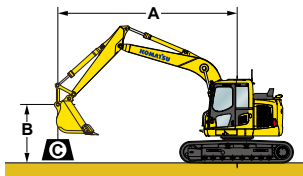

- A: Reach from swing centre
- B: Bucket hook height
- C: Lifting capacity
- Cf: Rating over front
- Cs: Rating over side
- ⊗: Rating at maximum reach

### Conditions:

- Boom length: 4600 mm
- Arm length: 2500 mm
- Shoes: 500 mm steel city pattern
- Bucket: 400 kg

Unit: kg

B \ A	3.0 m		4.6 m		6.1 m		⊗ MAX	
	Cf	Cs	Cf	Cs	Cf	Cs	Cf	Cs
6.1 m			*2960	*2960			*1610	*1610
3.0 m	*6010	6010	*4210	3400	3350	2110	*1490	1490
0.0 m	*5800	5800	5010	3020	3140	1930	*1850	1500
-3.0 m	*7270	5890	4800	2950			3340	2130

\*Load is limited by hydraulic capacity rather than tipping. Ratings are based on SAE standard No. J1097. Rated loads do not exceed 87% of hydraulic lift capacity or 75% of tipping load.





## STANDARD EQUIPMENT

- 2 speed travel with auto shift
- Alternator, 60 Ampere, 24V
- AM/FM radio
- Arm, 2500 mm
- Automatic air conditioner
- Automatic engine warm-up system
- Auto idle
- Auto idle shut down
- Auxiliary input (3.5mm jack)
- Batteries, large capacity (2 x 12V)
- Battery isolation switch, lockable
- Blade assembly
- Boom, 4600 mm
- Boom and arm burst valve protection
- Cab guards
  - Lower front window guard
  - Integrated top guard, OPG Level 1
  - Bolt on top guard, OPG Level 2
- Carrier rollers, (2 each side)
- Converter, (2) x 12V
- Counterweight, 2640 kg
- Dry type air cleaner, double element
- Dual flow hammer piping
- Electric horn
- Emergency stops (3)
- Engine, Komatsu SAA4D95LE-7
- EMMS monitoring system
- Engine overheat prevention system
- Fan guard structure
- Fuel system pre-filter 10 micron
- Grease sealed track chain
- High back air suspension seat, with heat
- High pressure in-line hydraulic filters
- Hydraumind closed centre load sensing system
- KOMTRAX Level 5.0
- Large LCD colour monitor, high resolution
- Level indicator
- Lock lever
- Lock lever, auto lock
- Mirrors (LH & sidewise)
- Operator identification system
- Overload alarm
- PPC hydraulic control system
- Proportional control handles
- Provision for tilt circuit, including valve
- Pump/engine room partition cover
- Radiator and oil cooler dustproof net
- Rear reflectors
- Rearview monitoring system (1 camera)
- Revolving frame undercovers, heavy duty
- ROPS cab (ISO 12117-2) with vandal guard provisions
- Rotating beacon with guard
- Seat belt indicator
- Seat belt, retractable, 78mm
- Secondary engine shutdown switch
- Slip resistant foot plates
- Starter motor, 4.5 kW/24V x 1
- Suction fan with viscous clutch
- Thermal and fan guards
- Track frame swivel guard
- Track roller guides, 1 each side
- Track rollers, 7 each side
- Track shoes, steel city pattern, 500 mm
- Travel alarm
- Quick hitch piping with safety switch and alarm
- Working lights
  - 1 x boom
  - 2 x cab
- Working mode selection system



## OPTIONAL EQUIPMENT

- Additional counterweight, 500 kg
- Arm, 2100 mm
- Arm, 3000 mm
- Autogrease system
- Battery isolation switch, dual pole, lockable
- Cab vandal guard set
- Canvas seat cover
- Fire extinguisher, 1.5 kg
- Fire extinguisher, 4.5 kg
- Fire extinguisher, 9 kg
- Fuel cap vandal guard
- Jump start receptacle
- Komvison
- Radio, multimedia system
- Radio, UHF
- Starter circuit isolation, lockable
- Track shoes, rubber road liner, 500 mm
- Track shoes, triple grouser, 500 mm
- Track shoes, triple grouser, 600 mm
- Turbo timer
- Window tinting



## ATTACHMENT OPTIONS

- Bucket, general purpose, KGA 450 mm, 0.21 m<sup>3</sup>
- Bucket, general purpose, KGA 600 mm, 0.32 m<sup>3</sup>
- Bucket, general purpose, KGA 900 mm, 0.53 m<sup>3</sup>
- Bucket, slope finishing, KGA 1600 mm, 1.10 m<sup>3</sup>
- Quick hitch, KGA, dual lock
- Quick hitch, KGA, dual lock, tilting
- Ripper, KGA, single tyne

## COMING SOON

### KOMATSU JMHB130H-1 Hydraulic Breaker



Model Type	JMHB130H-1	
Working weight	kg	730
Oil flow (min - max)	ℓ /min	80 - 140
Operating pressure (max)	MPa	140
Impact rate	bpm	870
Chisel diameter	mm	106
Acceptable back pressure	bar	15
Base machine (min - max)	Ton	8 - 18

For a complete list of available attachments, please contact your local Komatsu representative

