

KOMATSU

D61EXi-24 D61PXi-24

intelligent / 2.0
MACHINE CONTROL

EPA Tier 4 Final Engine
Australia & New Zealand Specifications



Photos may include optional equipment

Crawler dozer

NET Horsepower
125 kW @ 2200 rpm
168 HP @ 2200 rpm

Operating weight range
D61EXi-24: 18640 kg
D61PXi-24: 19580 kg

Blade capacity
D61EXi-24: 3.4 m³
D61PXi-24: 3.8 m³

Next generation intelligence

No cables

No coiled cables between machine and blade.

No climbing

GNSS antenna and mast removed from blade.

No connections

No daily connections required between machine and blade.

Innovative

Automated blade control from rough dozing to finish grade.

Integrated

Standard factory installed machine control system.

Intelligent

New dozing mode, load control performance features.

NET Horsepower

125 kW @ 2200 rpm
168 HP @ 2200 rpm

Operating weight

D61EXi-24: 18640 kg
D61PXi-24: 19580 kg

Blade capacity

D61EXi-24: 3.4 m³
D61PXi-24: 3.8 m³



Photos may include optional equipment.

Innovative. Integrated. Intelligent.

Standard intelligent machine control

Standard factory installed integrated 3D GNSS intelligent machine control system.

Improved machine control

Up to 8% more efficient dozer operation than comparable aftermarket machine control systems in start to finish grading tests.



Factory installed machine control components

Machine control components are factory installed and designed as an integral part of the base machine for improved durability.

Komatsu quality

Machine control components and system validated to Komatsu's rigorous quality & durability standards.

Industry standard compatibility

Machine control system makes use of common industry design data file and supports typical base station communication.

Simple operator interface

Simple touch screen control box with multi-color customisable display.

3D GNSS machine control standard

All on-machine components are standard and include control box, GNSS receiver/radio, GNSS antenna, and enhanced inertial measuring unit sensor.

Finish grade performance

Enhanced sensor package and intelligent logic provides for finish grade accuracy in an integrated system without traditional blade mounted sensors.

Enhanced Inertial Measuring Unit (IMU+)

Chassis mounted enhanced inertial measuring unit (IMU+) and intelligent logic provides for finish grade accuracy without blade mounted sensors.

Cab top GNSS antenna

Load control intelligence controls blade elevation to improve productivity and minimise track slip by adjusting blade load. 25mm from grade or 2.5mm from grade – you can also run in auto mode.

Intelligent dozing mode settings

Operators are able to select between 4 distinct machine control operating modes to optimise performance to the application i.e. cutting, spreading, trimming etc.

Operator selectable load settings

Machine control load settings can be adjusted between presets to tailor a response to material conditions.

New Komatsu SAA6D107E-3, variable geometry, turbocharged and aftercooled, 6.7 litre diesel engine is EPA Tier 4 Final emissions certified.

Fluid neutral or better

Fuel & DEF TOTAL consumption is less than the fuel consumed compared to previous model.

New Komatsu Diesel Particulate Filter (KDPF) and Selective Catalytic Reduction (SCR) systems reduce particulate matter and NOx, while providing automatic regeneration that does not interfere with daily operation. This assists operation efficiency.

New higher performance Variable Geometry Turbocharger (VGT) uses a hydraulic actuator to provide optimum air flow under all speed and load conditions.

New Komatsu auto idle shutdown helps reduce excessive idle time and increases service interval time.

Rear hydraulics (standard)

Rear view monitoring system (standard)

New large color monitor:

- Easy-to-read large 7" high-resolution multi-color monitor
- Easy-to-use multiple tabular menus
- Easy-to-use onboard diagnostics that don't require a laptop
- Ecology guidance for efficient operation

Integrated ROPS cab features:

- Large, quiet, pressurised cab
- Excellent visibility with integrated ROPS structure
- Air suspension high-capacity heated seat

New high-engine-RPM (H) mode helps maintain ground speed during heavy blade load applications.

Parallel Link Undercarriage System (PLUS)

provides up to double the wear life and lowers repair and maintenance costs.

Triple labyrinth final drive provides additional protection for the final drive floating seals.

Intelligent machine control

Automatic blade control, ranging from heavy dozing to finish grading

The D61EXi/PXi-24 features a 3D GNSS (Global Navigation Satellite System) machine control system which automatically controls the blade elevation and tilt by target design data. Not only can the automatic machine control features be used for finish grading but also for heavy (rough) dozing.

Loading of the blade at the start of the cut is controlled by set parameters. During the pass, if the blade load increases during heavy dozing operation, the blade is automatically raised to control the load and minimise shoe slip to ensure efficient dozing. When the blade approaches the target design surface, the blade will follow it for accurate finish grading.



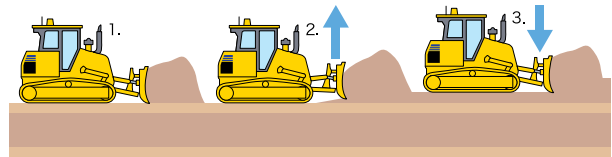

1. Blade moves to target surface until load reaches a preset level.
2. The blade automatically raises to minimise track slip.
3. Should the load decrease, blade will lower to re-load blade to an optimum level.



Operator selectable dozing mode, blade load settings



Dozing mode settings

Optimise machine performance for the given operation or application.

-  **Cutting and carry**
Long, shallow cuts
-  **Cutting**
Front to back dozing
-  **Spreading**
Spreading a pile of material
-  **Simple grading**
Severe grade breaks, transitions

Blade load mode settings

Tailor blade loads to material conditions.

-  **Light**
Low traction application, low blade load due to material characteristics
-  **Normal**
Typical operation
-  **Heavy**
High traction application, high blade load due to material characteristics

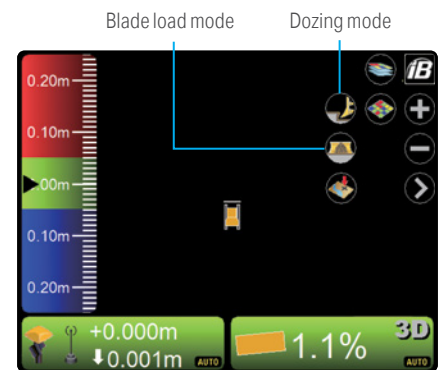

Auto/manual switch

Multiple passes, forward and reverse, can be made with automatics activated the entire time.



As-built Mapping Display for Checking Construction Progress

Cab top GNSS antenna provides for accurate as-built surface data collection by measuring actual elevations as machine continuously tracks in operation.

Proactive dozing control

Operator can utilise automatic blade control from rough grading to finish grading work. Proactive dozing control understands the terrain in the path of each cut, maximises the blade load throughout the pass, regardless of the terrain ahead, and achieves productivity similar to that of an experienced operator.

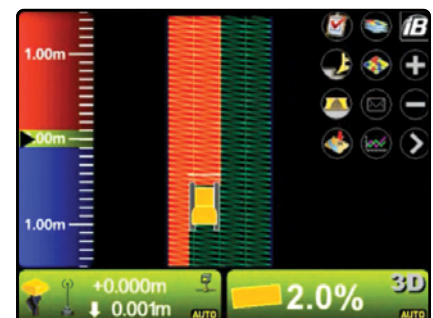
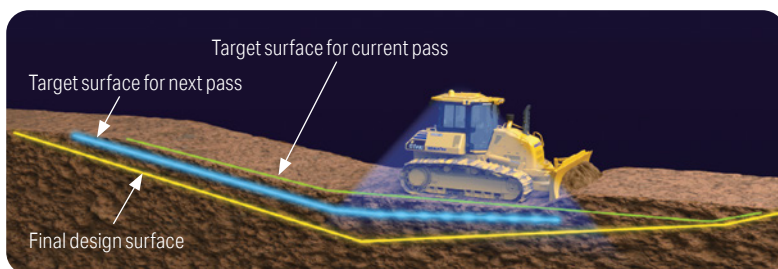



Advanced sensor technologies for performance

GNSS antenna

Mounted to top of cab to minimise damage – not on the blade.



Enhanced inertial measuring unit (IMU+)

Chassis mounted IMU+ and intelligent logic enables accurate grading performance without blade mounted sensors.



Intelligent machine control system

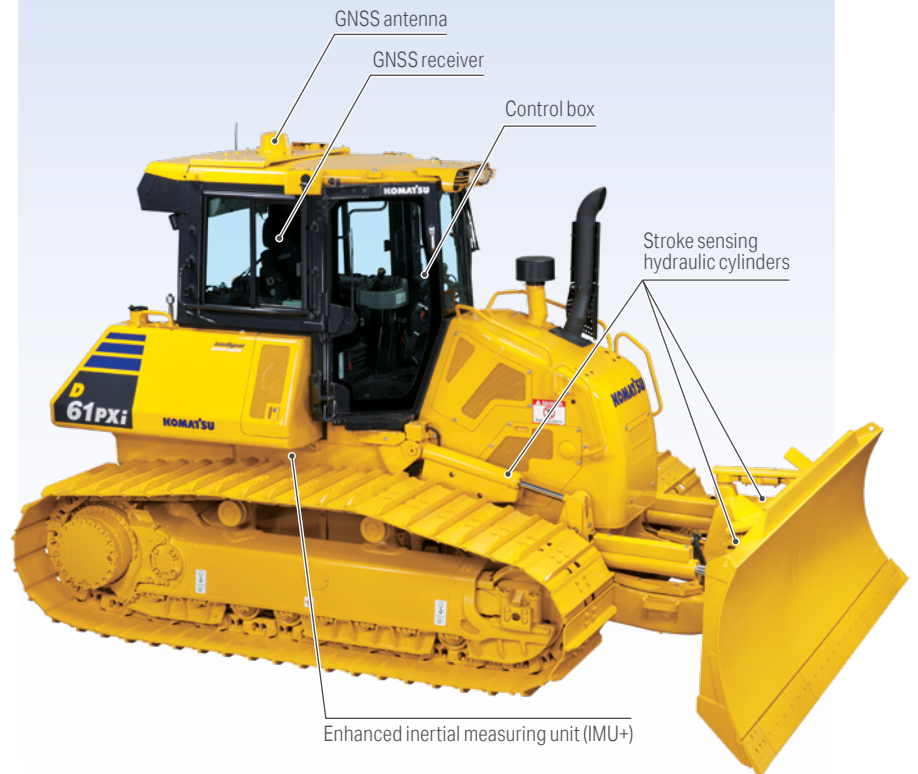

Control box

Easy to use touchscreen display features bright graphics and customisable views. Mounting allows viewing angle to be adjusted per operator preference.

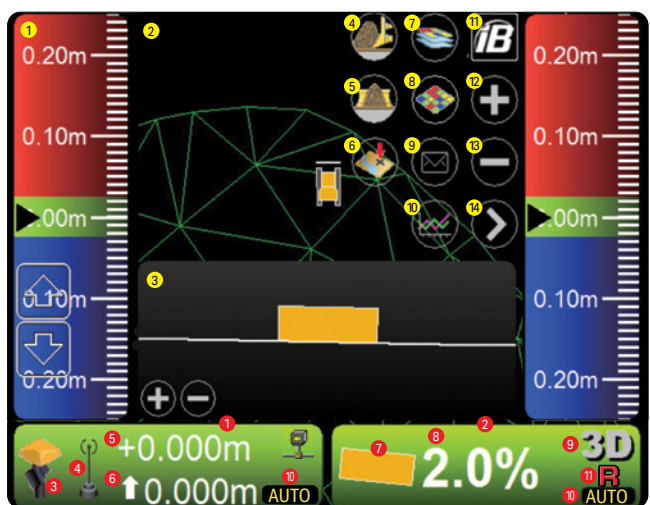

- 1 Elevation control key
- 2 Slope control key
- 3 GNSS status
- 4 Radio status
- 5 Cut / Fill offset
- 6 Cut / Fill reading
- 7 Tilt of blade
- 8 Design cross-slopes
- 9 Type of control
- 10 AUTO indicator
- 11 Back Grade mode indicator

This is a typical main screen of control box.

Stroke sensing hydraulic cylinders

Robust stroke sensing hydraulic cylinders employ proven Komatsu sensor technologies for accurate finish grade performance.



Factory installed machine control system for quality, durability

Machine control system components are factory installed and designed as an integral part of the machine.

- 1 Left window
- 2 Main window
- 3 Lower window
- 4 Dozing mode selection
- 5 Blade load selection
- 6 Take a topo shot
- 7 Toggle AS-BUILT mode
- 8 Start/Stop AS-BUILT updates
- 9 Sitelink messaging
- 10 Sitelink activity
- 11 iB logo key
- 12 Zoom in key
- 13 Zoom out key
- 14 Toggle main view

Performance features

Intelligent machine control system

Komatsu's New Emission Regulations-compliant Engine

A refined engine that complies with respective NOx emissions. In addition to refining the Tier 4 Interim technologies, Komatsu developed a new Selective Catalytic Reduction (SCR) device in-house.

Technologies applied to the new engine

Heavy-duty aftertreatment system

This new system combines a Komatsu Diesel Particulate Filter (KDPF) and Selective Catalytic Reduction (SCR). The SCR NOx reduction system injects the correct amount of DEF at the proper rate, transforming NOx into non-toxic water (H2O) and nitrogen gas (N2).

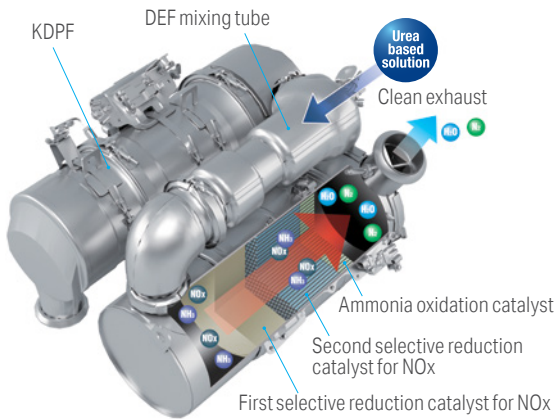

Heavy-Duty cooled Exhaust Gas Recirculation (EGR) system

The system recirculates a portion of exhaust gas into the air intake and lowers combustion temperatures, thereby reducing NOx emissions. EGR gas flow has been decreased for Tier 4 Final with the addition of SCR technology.

The system achieves a dynamic reduction of NOx, while helping reduce fuel consumption below Tier 4 Interim levels.

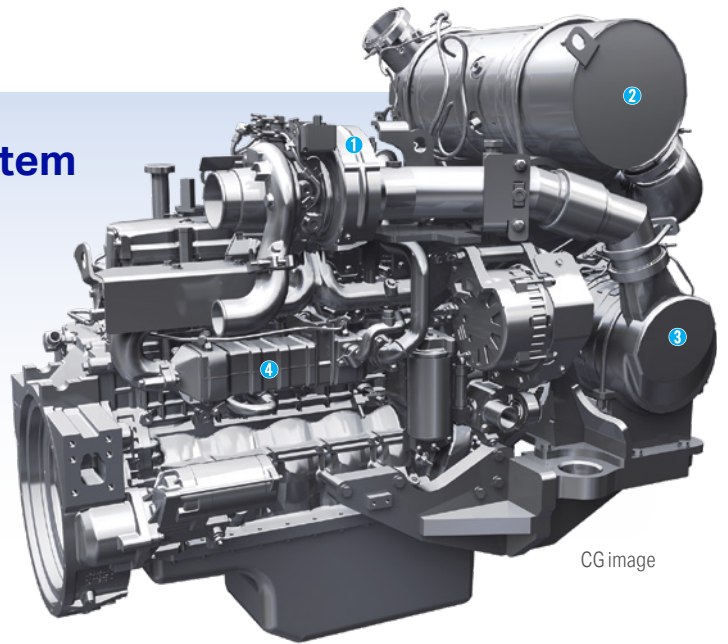
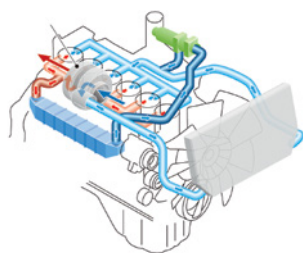

CG image

- 1 Variable Geometry Turbocharger (VGT)
- 2 Selective Catalytic Reduction (SCR)
- 3 Komatsu Diesel Particulate Filter (KDPF)
- 4 Exhaust Gas Recirculation (EGR) cooler

Advanced electronic control system

The electronic control system performs high-speed processing of all signals from sensors installed in the vehicle, providing total control of equipment in all conditions. Engine condition information is displayed via an on-board network to the monitor inside the cab, providing necessary information to the operator. Additionally, managing the information via KOMTRAX helps customers keep up with required maintenance.

Variable Geometry Turbocharger (VGT) system

The VGT system features proven Komatsu design hydraulic technology for variable control of air-flow and supplies optimal air according to load conditions.

It provides better exhaust temperature management. The Tier 4 final version has an improved propeller design for increased performance.

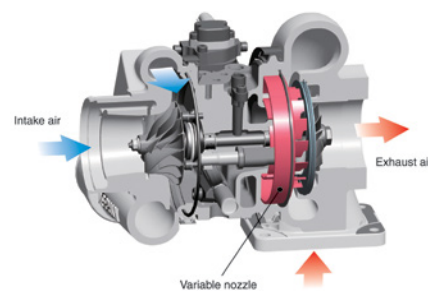

Heavy-Duty High-Pressure Common Rail (HPCR) fuel injection system

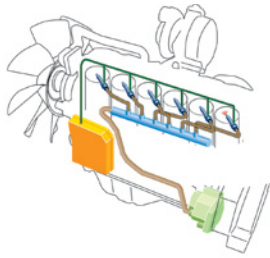

The system is designed to achieve an optimal injection of high-pressure fuel by means of computerised control, providing close-to-complete combustion to reduce PM emissions. The high pressure injection, thereby reducing both PM emissions and fuel consumption over the entire range of engine operating conditions. The Tier 4 Final engine has advanced fuel injection timing for reduced fuel consumption and lower soot levels.

Redesigned combustion chamber at top of piston. The combustion chamber at the top of the piston has a new shape designed to improve combustion and further reduce NOx, PM, fuel consumption and noise.

Komatsu Closed Crankcase Ventilation (KCCV)

The KCCV efficiency is significantly increased from previous models from approximately 50% to 95% efficiency.



Komatsu Auto Idle Shutdown

Komatsu auto idle shutdown automatically shuts the engine down after idling for a set period of time to reduce unnecessary fuel consumption and exhaust emissions. The amount of time before the engine is shutdown can be programmed easily from 5 to 60 minutes.

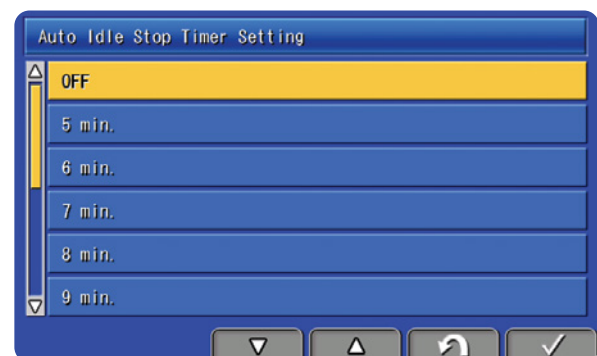

Productivity and fuel economy features

Hydrostatic Transmission (HST) control system

The HST controller monitors engine output and work load. It controls HST pump and motor displacement to provide the optimum speed and drawbar pull. Full power to both tracks during turns or counter-rotation makes the D61EXi/PXi-24 extremely maneuverable.



Fuel efficiency

The efficient HST control system assists in reducing fuel consumption.

Hydraulically driven cooling fan

The engine cooling fan's speed is electronically controlled. Fan speed depends on engine coolant and oil temperatures. The fan will only rotate as fast as necessary to adequately cool the machine's fluid. This system increases fuel efficiency, reduces operating noise levels and uses less horsepower than a belt-driven fan.

Long track-on-ground and oscillating track frame

Long machine track-on-ground and oscillating track frames improve stability and grading/dozing performance.

Selectable working mode

P mode: Designed for powerful operation and maximum production.

E mode: Designed for general dozing applications, providing adequate speed and power, while saving energy. For fuel reduction and energy saving, the monitor panel allows the operator to switch the working mode easily, depending on the work at hand.

P mode (Power mode): The engine runs full power, allowing the machine to perform the work requiring large production, heavy loads and uphill work.

E mode (Economy mode): The engine uses enough power for the work, without delivering unnecessary power. This mode enables energy saving operation. It is ideal on hard or rough surfaces that often cause shoe slip, and work requiring less power, such as downhill dozing, leveling and light-load work.

H mode (high engine idle speed mode) [New]: This setting allows subtle changes in load to be detected, which is tailor-made for power-intensive work. Compared to P mode, the engine high-idle speed is higher in H mode.

PAT dozer with adjustable pitch

A power angle power tilt dozer blade with adjustable blade pitch system is standard for both D61EXi/PXi-24 machines. The hydraulic blade tilt, angling function (and manually adjustable blade pitch) add versatility and productivity in a variety of applications.

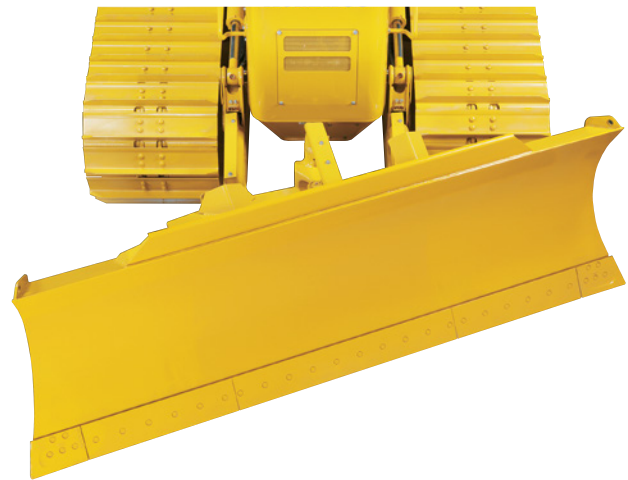
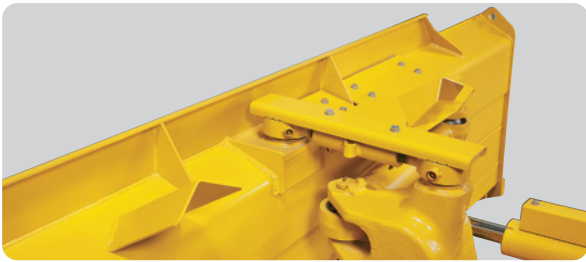

Increased wear life blade skin

The hardness of the blade skin has been improved for increased wear life and overall durability.

Unrivaled blade visibility

The D61EXi/PXi-24 incorporates Komatsu's super-slant nose design. Komatsu's innovative design provides excellent blade visibility for improved machine control and increased efficiency and productivity. It's class leading!

Tie off points standard (ISO 14567)

When working in elevated positions, four tie off points (1 at each corner of the cab) provide anchors for technician harness lanyards.



Control features



Palm Command Control System (PCCS) Levers

Komatsu's ergonomically-designed PCCS handles create an operating environment with complete operator control.

PCCS

The low-effort PCCS joystick controls all directional movements, including machine travel speed as well as counter-rotation.

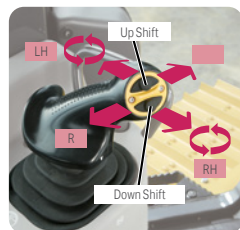

Electronic controlled hydraulic system

The electronic controlled, palm commanded joystick provides precise blade control. New blade angling switch operation provides easier and predictable blade control.

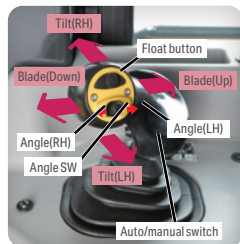

Hydrostatic transmission with electronic control

The D61EXi/PXi-24 is equipped with Komatsu-designed HST that allows for quick-shift or variable speed selection. The HST features dual-path closed-circuits with two variable displacement piston pumps and two variable displacement travel motors. Hydrostatic steering eliminates steering clutches and brakes, providing smooth powerful turns. Fully electronic control provides full automatic shifting and enables smooth control. An electronic fuel control dial controls engine speed.

One-pedal design (decelerator/brake pedal) controls speed, during operation

Machine operation is simple due to brake function integration into the decelerator pedal. Machine travel speed can be controlled using one pedal. The pedal function can be changed by a mode selector switch.

Decelerator mode: The pedal can decelerate engine rpms and vehicle travel speed. It can be used for all applications.

Brake mode: The pedal can decelerate vehicle travel speed while maintaining high-engine speed. This mode can be helpful to maintain work-equipment speed, while using the brake function.



Working environment

Integrated ROPS (ISO 3471) cab

The D61EXi/PXi-24 has an integrated ROPS (ISO 3471) cab. High rigidity and superb sealing performance sharply reduce noise and vibration for the operator and mitigate dust from entering the cab. In addition, side visibility is increased because external ROPS (ISO 3471) structure and posts are not required.



Comfortable ride with heated operator seat

The operator seat has adjustable lumbar support, tilt and an electric heater. It is easy to adjust to the operator's shape. Also, standard seat heat makes it possible to work comfortably in the winter.



Comfortable ride with cab damper mounting

The D61EXi/PXi-24's cab mount uses a cab damper system that provides shock and vibration absorption conventional mounting systems cannot match. The silicon-oil-filled cab damper mount helps to isolate the cab from the machine body, suppressing vibration and providing a quiet, comfortable operating environment.

Auxiliary input jack and two electrical outlets

By connecting an auxiliary device to this plug input, the operator can play audio from a mobile device through the machine's sound system. Two DC 12 volt electrical outlets provide a power source for a radio or other equipment.



Two DC12V electrical outlets

Auxiliary input jack

Additional operator safety features

Rear view monitor system

On the large LCD color monitor, the operator can view, through one camera, areas directly behind the machine. This camera can be synchronised with reverse operation.



Secondary engine shutdown switch

A secondary switch has been added at the side of the front console to shut down the engine.



Reliability & maintenance features

Excellent Reliability & Durability

Parallel Link Undercarriage System (PLUS)

Komatsu's PLUS provides less downtime and longer wear, with up to 40% lower undercarriage maintenance costs. Rotating bushings eliminate the cost and downtime of bushing turns, and strengthened rollers and links increase wear life by up to 100 percent. With PLUS, individual links can be replaced with common track tools.

Modular design

One of the design goals behind the creation of the D61EXi/PXi-24 was to manufacture a more durable machine. This was achieved by reducing component complexity and using a strong modular design for increased serviceability and durability. Steel castings reduce the number of welds, improving rigidity and strength.

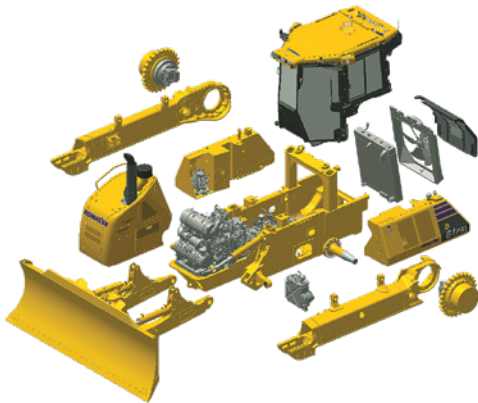

Self-adjusting idler support

The self-adjusting idler support provides constant and even tension on idler guide plates reducing noise and vibration and increasing undercarriage life.

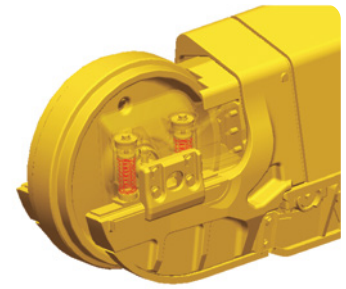

Easy maintenance

Planned maintenance and daily checks are the only way to ensure long service life from equipment. Komatsu has designed the D61EXi/PXi-24 with conveniently located maintenance and inspection points for easy accessibility.

Hydraulically-driven swing-up fan

The D61EXi/PXi-24 utilises a swing-up fan with a gas strut-assisted lift system to provide easy access to the (side-by-side) radiator, oil cooler and charge air cooler. The hydraulic fan has a cleaning mode which can be used for periodic cooler cleaning.



KOMTRAX equipment monitoring

Get the whole story with



What

- KOMTRAX is Komatsu's remote equipment monitoring and management system. KOMTRAX continuously monitors and records machine health and operational data.
- Information such as fuel consumption, utilisation, and a detailed history lowering owning and operating cost.

Who

- KOMTRAX is standard equipment on all Komatsu construction products.

When

- Know when your machines are running or idling and make decisions that will improve your fleet utilisation.
- Detailed movement records ensure you know when and where your equipment is moved.
- Up to date records allow you to know when maintenance is due and help you plan for future maintenance needs.

Where

- KOMTRAX data can be accessed virtually anywhere through your computer, the web or your smart phone.
- Automatic alerts keep fleet managers up to date on the latest machine notifications.

Why

- Knowledge is power – make informed decisions to manage your fleet better.
- Knowing your idle time and fuel consumption will help maximise your machine efficiency.
- Take control of your equipment – any time, anywhere.



KOMTRAX

For construction and compact equipment.

KOMTRAX Plus

For production and mining class machines.



Specifications

Engine

Model	Komatsu SAA6D107E-3*
Type	4-cycle, water-cooled, direct injection
Aspiration	Komatsu Variable Geometry Turbocharged, air-to-air aftercooled, cooled EGR
Number of cylinders	6
Bore x stroke	107 mm x 124 mm
Piston displacement	6.69 ltr
Governor	All-speed and mid-range, electronic
Horsepower	
SAE J1995	Gross 127 kW 170 HP
ISO 9249 / SAE J1349	Net 125 kW 168 HP
Hydraulic fan at maximum speed	Net 113 kW 152 HP
Rated rpm	2200 rpm
Fan drive type	Hydraulic
Lubrication system	
Method	Gear pump, force lubrication
Filter	Full-flow

*EPA Tier 4 Final emissions certified

Hydrostatic Transmission

Dual-path, hydrostatic transmission provides infinite speed changes up to 9.0 km/h. The variable capacity travel motors allow the operator to select the optimum speed to match specific jobs. Travel control lock lever and neutral switch.

Travel speed (quick shift mode)*	Forward	Reverse
1st	0–3.4 km/h	0–4.1 km/h
2nd	0–5.6 km/h	0–6.5 km/h
3rd	0–9.0 km/h	0–9.0 km/h

*Quick shift speeds are adjustable in the monitor.

Travel speed (variable mode)	Forward	Reverse
	0–9.0 km/h	0–9.0 km/h

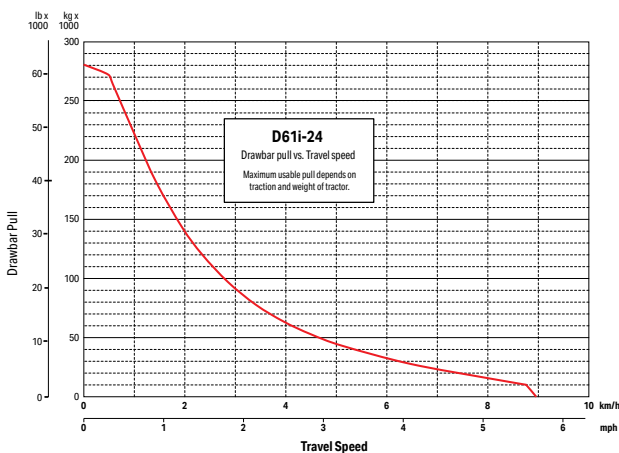

Final Drives

In-shoe mounted axial piston type travel motors with integrated two-stage planetary gear reduction. Compact in-shoe mount reduces risk of damage by debris. Bolt-on sprocket for easy displacement.

Steering System

PCCS joystick control for all directional movements. Pushing the joystick forward results in forward machine travel, while pulling it backward reverses the machine. Simply tilt the joystick to the left or right to make a turn. Tilting the joystick fully to the left or right activates counter-rotation. HST eliminates steering clutches and brakes, providing smooth, powerful turns. Fully electronic control enables smooth operation. The PCCS utilises shift buttons to increase and decrease speed.

Minimum turning radius	
D61EXi-24	2.1 m
D61PXi-24	2.3 m

Undercarriage

Suspension	Oscillating-type with equaliser bar and pivot shafts
Track roller frame	Monocoque, large section, durable construction
Rollers and idlers	Lubricated track rollers
Lubricated tracks	
Parallel Link Undercarriage System (PLUS) with lubricated rotating bushings for extended system wear life and lower maintenance costs. Track tension is adjusted easily with grease gun.	

	D61EXi-24	D61PXi-24
Number of track rollers (each side)	8	8
Type of shoes (standard)	Single grouser	Single grouser
Number of shoes (each side)	46	46
Grouser height	mm 57.5	57.5
Shoe width (standard)	mm 600	860
Ground contact area	cm ² 37980	54440
Ground pressure (with dozer, ROPS cab) (ISO 16754)	kPa 43.37	31.78
	kgf/cm ² 0.44	0.32
Track gauge	mm 1900	2130
Length of track on ground	mm 3165	3165

Service Refill Capacities

Coolant	45 ltr
Fuel tank	372 ltr
Engine oil	27 ltr
Hydraulic tank	101 ltr
Final drive (each side)	8.1 ltr
DEF tank	20.6 ltr

Operating Weight (approximate)

Tractor weight:	
Including ROPS (ISO 3471) cab, C frame for PAT dozer, rated capacity of lubricant, coolant, full fuel tank, operator and standard equipment.	
D61EXi-24	17650 kg
D61PXi-24	18440 kg
Operating weight:	
Including PAT dozer, ROPS (ISO 3471) cab, operator, standard equipment, rated capacity of lubricant, coolant and full fuel tank.	
D61EXi-24	18640 kg
D61PXi-24	19580 kg

Dimensions

	D61EXi-24	D61PXi-24
A	3250 mm	3860 mm
B	435 mm	515 mm
C	1195 mm	1155 mm
D	1025 mm	1025 mm
E	580 mm	580 mm
F	3165 mm	3165 mm
G	5480 mm	5480 mm
H	3340 mm	3340 mm
I	57.5 mm	57.5 mm
J	1900 mm	2130 mm
K	610 mm	860 mm
L	2500 mm	2990 mm
M	2980 mm	3530 mm
N	6100 mm	6220 mm
Ground clearance		390 mm

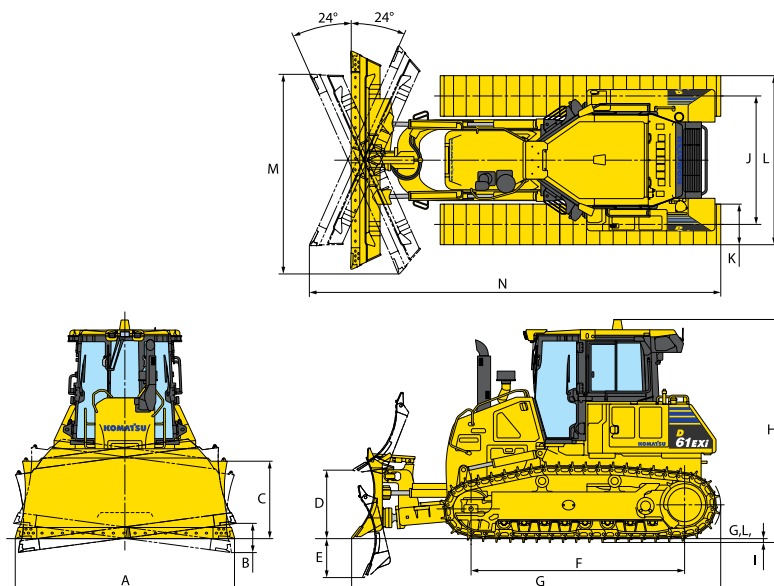

Hydraulic System

Closed-Center Load Sensing System (CLSS) designed for precise and responsive control, and for efficient simultaneous operation.

Hydraulic control unit:

All spool control valves externally mounted remote to the hydraulic tank. Piston-type hydraulic pump with capacity (discharge flow) of 171 ltr/min at rated engine rpm.

Relief valve setting 27.4 MPa 280 kg/cm²

Hydraulic cylinders Double-acting, piston type

	Number of cylinders	Bore
Blade lift	2	100 mm
Blade tilt	1	120 mm
Blade angle	2	110 mm

Hydraulic oil capacity (refill):

Power angle tilt dozer 101 ltr

Control valves:

3-spool control valve for Power Angle Tilt dozer

Positions:

Blade lift Raise, hold, lower, and float

Blade tilt Right, hold, and left

Blade angle Right, hold, and left

Additional control valve required for ripper:

Positions:

Ripper lift Raise, hold, and lower

Dozer Equipment

	Overall Length With Dozer mm	Blade Capacity m ³	Blade Width x Height mm	Max. Lift Above Ground mm	Max. Drop Below Ground mm	Max. Tilt Adjustment mm
D61EXi-24 Power Angle Tilt Dozer	5480	3.4	3250 x 1195	1025	580	435
D61PXi-24 Power Angle Tilt Dozer	5480	3.8	3860 x 1155	1025	580	515

Blade capacities are based on the SAE recommended practice J1265. Use of high-tensile-strength steel in moldboard for strengthened blade construction.

Standard equipment

Engine

- Air cleaner, double element with dust indicator
- Air intake pipe with pre-cleaner
- Cooling fan, rear, hydraulic driven with cleaning mode
- Diesel Exhaust Fluid dosing system (DEF)
- Engine, Komatsu SAA6D107E-3 diesel EPA final Tier 4 emission regulation arrangement
- EGR - Heavy duty cooled Exhaust Gas Recirculation
- Exhaust pipe, elbow type
- Fuel filtration, water separator / pre-cleaner - 10 micron; filter - 2 micron; with strainer in fuel tank fill
- KCCV - Komatsu Closed Crankcase Ventilation
- KDPF - Komatsu Diesel Particulate Filter after-treatment assembly consisting of KDOC & KCSF
- KVGT - Komatsu Variable Geometry Turbocharger
- SCR - Selective Catalyst Reduction assembly

Electrical System

- Alternator, 24V, 90 Amp.
- Automatic idle shutdown system
- Batteries, large capacity 2 x 12V 200Ah
- Engine shutdown secondary switch
- Factory isolation / disconnection switch
- Sealed harness connectors
- Starting motor, 24V, 5.5kW

Powertrain & Controls

- Combination decelerator / brake pedal
- Final drive with planetary gear double reduction
- Hydrostatic Steering System (HSS) with counter rotation
- Hydrostatic Transmission with electric control
- Palm Command Control System (PCCS)
- Quick shift and variable speed selection modes

Hydraulics & Controls

- Auto blade on / off switch
- Blade cylinder hoses, protected
- CLSS - Closed-centre Load Sensing System
- Electronic float function
- EPC accumulator
- O-ring face seal hydraulic connectors
- Palm Command Electronic Controlled Blade Joystick
- Rear hydraulics - for ripper or level 1 winch

Undercarriage

- Self adjusting idler support with recoil spring
- Sprockets, segmented teeth type with mud release notches
- Track link - PLUS with heavy duty links Parallel Link Undercarriage System
- Track roller guards, segmented full length
- Track rollers x 8, Carrier rollers x 2
- Track shoes, 610mm, single grouser (EXi only)
- Track shoes, 860mm, single grouser (PXi only)

Protectors, Guards & Covers

- Engine hood and side covers
- Fenders, standard length
- Front guard, perforated
- Radiator mask, louver type
- Sprocket inner guard
- Under guards

intelligent Machine Control (iMC)

- Automatic reverse grading option with vertical offset switches
- Machine control monitor & hard carry case
- ICT Controller, GNSS antenna, MC-R3 receiver UHF digital II
- IMU - Inertial Measuring Unit chassis mounted
- Integrated 3D machine control GNSS (Global Navigation Satellite System)
- Network kit - 2 x magnetic base,
- 1 x modem antenna NextG,
- 1 x high gain UHF antenna 450-470 digital,
- Tokara ready modem & modem bracket
- Stroke sensing cylinders
- Support Service Level Agreement

Work Equipment

- Blade - 3.4m³ Power Angle Tilt (PAT) 3,250mm, with manual pitch operation (EXi only)
- Blade - 3.8m³ Power Angle Tilt (PAT) 3,860mm, with manual pitch operation (PXi only)
- Ripper assembly - Multi shank type, fixed digging angle, 3 x ripper shanks

Operator Cabin

- Air conditioner
- Cabin, integrated ROPS/FOPS design, pressurised, with viscous damper mounts
- Foot rests, high mount
- Lunchbox & cup holder
- Multi function colour monitor, 7 inch LCD
- Rear view mirror
- Rear view monitoring system
- Seat, air suspension type, fabric, low back, reclining with head rest
- Seat belt 78mm, retractable with caution alarm

Other Standard Equipment

- Back-up alarm & warning horn
- Fire extinguisher 1.5kg in cabin
- Front pull hook
- Komatsu Machine Tracking System (KOMTRAX)
- Lights, 3 x front & 2 x rear (cab mounted)
- Light, beacon LED & guard
- Lockable filter caps & covers
- Power supply, 2 x 12 volt outlets
- Radio media system BT USB
- Radio UHF 80 channel
- Seat cover, canvas
- Switch, turbo timer - Muirhead

Multi-shank ripper

Weight	1757 kg
Beam length	2170 mm
Maximum lift above ground	560 mm
Maximum digging depth	665 mm



Standard equipment

- Emergency Stops Qty 3 - 1 x Inside cab, 2 x Outside cab
- IMC - 915 SS Radio Board

Equipment (Standard and / or Optional) complete or partial component can be changed from factory without prior notice.



D61EXi / PXi-24

intelligent / 2.0
MACHINE CONTROL



Product designs, specifications and/or data in this document are provided for informational purposes only and are not warranties of any kind. Product designs and/or specifications may be changed at any time without notice. The only warranties that apply to sales of products and services are Komatsu's standard written warranties, which will be furnished upon request.

Komatsu and other trademarks and service marks used herein are the property of Komatsu Ltd., Komatsu Australia Pty Ltd., Komatsu America Corp., Komatsu Mining Corp., or one of their affiliates, or the respective owners or licensees.

KOMATSU

[komatsu.com.au](https://www.komatsu.com.au)

