

KOMATSU

D39EX/EXi/PX/PXi-24



Crawler dozer

Net horsepower

105 HP @ 2,200 rpm
(77 kW @ 2,200 rpm)

Operating weight

D39EX-24: 21,891 lbs. (9,930 kg)
D39PX-24: 22,817 lbs. (10,350 kg)
D39EXi-24: 22,068 lbs. (10,010 kg)
D39PXi-24: 22,950 lbs. (10,410 kg)

Blade capacity

Power angle tilt (PAT) dozer
D39EX-24: 2.89 yd³ (2.21 m³)
D39PX-24: 3.14 yd³ (2.40 m³)
D39EXi-24: 2.89 yd³ (2.21 m³)
D39PXi-24: 3.14 yd³ (2.40 m³)

intelligent / 2.0
MACHINE CONTROL

Next-generation intelligence

How do you make one of the industry's most capable dozers even better? Make it smart. The slant-nosed, intelligent HST dozer features the latest Intelligent Machine Control (IMC) 2.0 capabilities.

Lift layer control

Engineered to achieve consistent lift layers with automatic control to help you increase your productivity.

Quick surface creation

Creates a temporary design surface with the press of a button.

Proactive dozing control

Cut and carry work performed with the smoothness of an experienced operator. Has the ability to operate automatically 100% of the time.

Tilt steering control

Help reduce the need for constant operator corrections toward the target point.

Two antennas to support multiple global navigation satellite system (GNSS)

Satellite signal stability and reception offer reliability and accuracy.

Factory-installed information and communication technology (ICT) system standard



Photo may include optional equipment



Innovative. Integrated. Intelligent.

Standard Intelligent Machine Control 2.0

Standard factory-installed integrated 3D GNSS Intelligent Machine Control system.

Factory-installed machine control components

Machine control components are factory-installed and designed as an integral part of the base machine to promote durability.

Komatsu quality

Machine control components and system are validated to Komatsu's quality and durability standards

Industry standard compatibility

Machine control system makes use of common industry design data file norms and supports typical base station communication.

Simple operator interface

Simple touch screen control box with multicolor customizable display.

3D GNSS machine control (standard)

All on-machine components are standard including control box, GNSS receiver/radio, GNSS antenna and enhanced inertial measuring unit sensor.

Finish grade performance

Advanced sensor package and intelligent logic drive finish-grade accuracy in an integrated system without traditional blade-mounted sensors.

Enhanced Inertial Measuring Unit (IMU+)

Chassis mounted enhanced inertial measuring unit (IMU+) and intelligent logic promotes finish grade accuracy without blade mounted sensors.

Dual cab-top GNSS antennas

Load control intelligence controls blade elevation to help improve productivity and minimize track slip by adjusting blade load. 1.0' from grade or 0.1' from grade — you can run in auto mode.

Intelligent dozing mode settings

Operators can select among four distinct machine control operating modes to drive optimized performance to the application whether cutting, spreading or other.

Operator selectable load settings

Machine control load settings can be adjusted between presets to tailor response to material conditions.

SAA4D95LE-7 variable flow turbocharged and aftercooled 3.26 liter diesel engine provides excellent fuel economy. This engine is EPA Tier 4 Final emissions certified.

Variable flow turbocharger uses a simple valve to drive optimum air flow under all speed and load conditions.

Komatsu Diesel Oxidation Catalyst (KDOC) and selective catalytic reduction (SCR) systems

help reduce particulate matter and NOx using passive regeneration 100% of the time. No active or manual regeneration is required.

New Komatsu Auto Idle Shutdown helps reduce excessive idle time.

Efficient cooling system:

- Electronically controlled, hydraulically driven fan is manually reversible
- Radiator cover with gas assisted lift cylinders opens easily for cleaning
- Side-by-side coolers made for increased cooling capacity

Integrated ROPS cab features:

- Large, quiet, pressurized cab
- Excellent visibility with integrated ROPS structure
- Heated air-ride seat with high-capacity suspension (standard)
- Standard aux jack and (2) 12V power convertors
- Bluetooth radio and LED worklights

Self-adjusting idler support engineered to provide constant and even idler tension, helping to reduce vibration and increase undercarriage life.

Parallel Link Undercarriage System (PLUS) provides exceptional wear life and helps to control repair and maintenance costs.

New triple labyrinth final drive provides additional protection for the final drive floating seals.

Power angle tilt (PAT) dozer with manually adjustable blade pitch drives increases in productivity in a variety of applications.

Comprehensive operator blade control:

- Palm Command Control System (PCCS)
- Electronic Proportional Control (EPC)
- Adjustable quick shift and variable shift modes
- Blade angle switch
- Three blade control settings
- Multiple-operator memory storage

Efficient hydrostatic transmission with electronic control:

- Customizable quick shift (three speeds) settings for the operator
- Variable speed selection (20 speeds)
- Low speed matching technology (large displacement pumps/efficient engine speed)
- HST control system can help reduce fuel consumption

Intelligent Machine Control (IMC)



Intelligent Machine Control (IMC) 2.0

D39EX/EXi/PX/PXi-24 utilizes IMC 2.0, a GNSS* system that automatically controls the blade to three-dimensional design data. IMC 2.0 utilizes industry-leading proactive dozing control logic, lift layer control, quick surface creation and tilt steering control. A two-antenna system supports multiple GNSS, which helps reduce downtime and promotes more work time. These added features are designed for enhanced production and efficiency.

*GNSS (global navigation satellite system): General term for satellite positioning systems such as GPS, GLONASS, etc.

Quick surface creation

Operators can create a temporary design surface with the press of a button. Designed to simplify infield surface creation within the control box, it allows for more utilization of IMC 2.0.



Tilt steering control

The blade automatically tilts under a heavy load to maintain a straight line of travel to help optimize productivity throughout each pass while helping to mitigate operator fatigue.



Auto/manual switch

A conveniently located on/off switch giving the operator control of when IMC 2.0 is active.



Function switches

Cut/fill offset switch

The target surface height can be quickly adjusted by pressing the offset switch (button).

Back grade mode switch

Allows for automatic control during back grading.

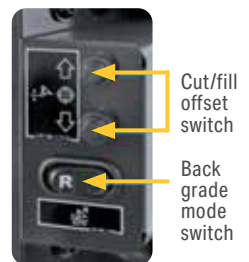

Lift layer control

Advance earthwork productivity and maintain compaction quality by automatically controlling lifts to the desired heights with respect to the mapped terrain. Excess fill is virtually eliminated as automatic blade control is engineered to follow finish surface once lifts have reached finish grade.

Proactive dozing control

Operators can utilize automatic blade control from rough grading to finish grading work. Proactive dozing control understands the terrain in the path of each cut, working to maximize the blade load throughout the pass, regardless of the terrain ahead and achieves productivity similar to that of an experienced operator.

Two antennas supporting multiple GNSS

Work accuracy is advanced by two antennas supporting the multiple GNSS.

Improvement of blade accuracy on slope

Blade accuracy is maintained during slope work.

Reliability of blade accuracy

Galileo, QZSS and BeiDou can be used in addition to GPS and GLONASS. The enhanced satellite capture rate allows the machine to be used in any time zone.

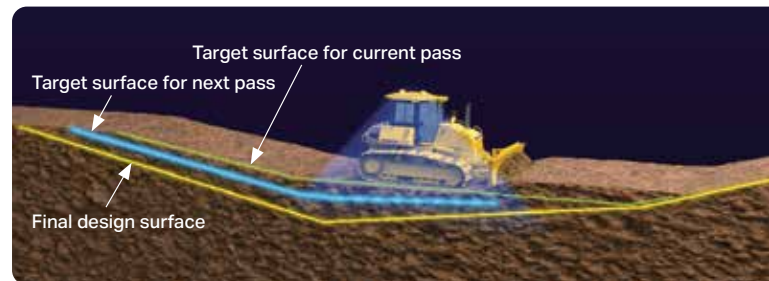
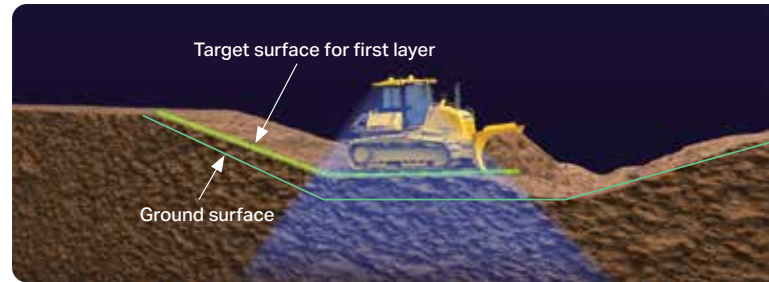

Control box

- 1 LH LED indicator 2 Upper LED indicator
- 3 RH LED indicator
- 4 Power ON/OFF and menu switch (Press: Display the main menu / Hold down: Turn ON/OFF the power supply)
- 5 Zoom in switch 6 Zoom out switch
- 7 Toggle main view switch (Press: Switch the display of main window / Hold down: Adjust the brightness and sound volume)
- 8 Left window 9 Main window 10 Lower window
- 11 Right window 12 Speed control ON/OFF
- 13 Take a topo shot 14 Simple grading ON/OFF
- 15 Cut depth selection 16 Smooth start ON/OFF
- 17 Tilt steering ON/OFF 18 Toggle As-built mode change view to [none], [cut fill], [pass counts]
- 19 Quick surface creation (Create slope plane surface)
- 20 Lift layer control (Create As-built design surface)
- 21 Elevation control key 22 Slope control key
- 23 GNSS status 24 Radio status 25 Cut/Fill offset
- 26 Cut/Fill reading 27 Tilt of blade
- 28 Design cross-slope 29 Type of control
- 30 AUTO indicator 31 Back Grade mode indicator
- 32 Lift indicator

*This is a typical main screen of control box.

Automatic dozing from grass to grade

Benefits of IMC 2.0



Improved finish grading

Applications: Finish grading

- Analyzes terrain and 3D model to proactively position blade in hard-to-grade areas
- Helps prevent overcutting at finish grade



Lift layer control

Applications: Lifting, compaction quality control

- Maintain precise lift thickness
- Automatically spreads lift from existing terrain and helps prevent overfill
- Up to double the production of prior model



Proactive dozing control

Applications: Stripping topsoil, high-production dozing

- Uses data from previous pass to plan the next pass
- Automatically cut/strip from existing terrain
- Helps new operators perform like experienced ones



Tilt steering control

- Automatically tilts blade to maintain straight travel while rough dozing
- Maintains consistent power to the ground and track

Use automation throughout the entire process

Bidding

Stripping topsoil ①

Mass excavation ②

Finish grading ③



* Compared to previous IMC control methods

** Compared to traditional methods

Performance features

Komatsu engine technologies

Emissions-compliant engine

Regulations effective in 2014 require the reduction of nitrogen oxide emissions. In addition to refining the U.S. EPA Tier 4 Interim technologies, Komatsu developed a new selective catalytic reduction (SCR) device in-house.

Technologies applied to engine

Water-cooled variable flow turbocharger

The variable flow turbocharger features simple and consistent technology that varies the intake air flow. Exhaust turbine wheel speed is controlled by a flow control valve that enables delivery of a precise volume of air to the engine combustion chamber under all speed and load conditions. This technology helps promote cleaner exhaust gas while maintaining power and performance.

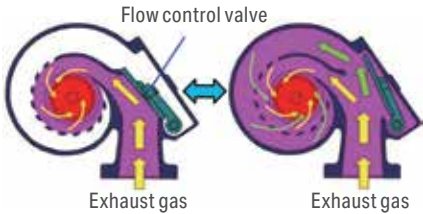

Heavy-duty aftertreatment system

This system consists of a Komatsu Diesel Oxidation Catalyst (KDOC) and a SCR. The SCR NOx reduction system injects the precise amount of diesel exhaust fluid (DEF) at the proper rate, thereby decomposing nitrogen oxide into water (H2O) and nitrogen gas (N2).

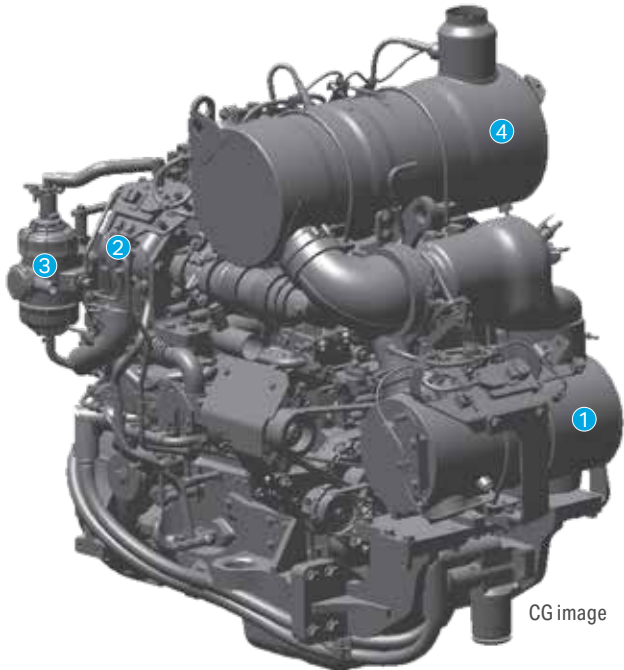
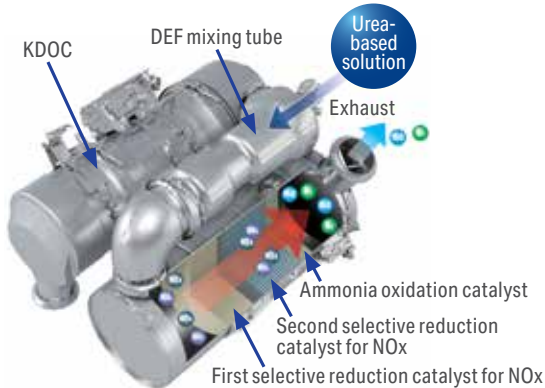

- 1 Komatsu Diesel Oxidation Catalyst (KDOC)
- 2 Variable flow turbocharger
- 3 Komatsu Closed Crankcase Ventilation (KCCV)
- 4 SCR

Cooled exhaust gas recirculation (EGR)

Cooled EGR, a dependable technology available in existing Komatsu engines, promotes reduced nitrogen oxide emissions. These components drive reliable performance during the demanding work conditions of construction equipment.

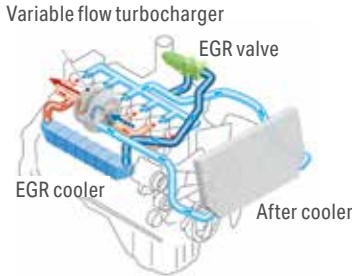

Komatsu Closed Crankcase Ventilation (KCCV)

Crankcase emissions (blow-by gas) are passed through a KCCV filter. The KCCV filter traps oil mist which is returned back to the crankcase while the gas, which is almost oil-mist-free, is fed back to the air intake.



Performance features

Heavy-duty high-pressure common rail (HPCR) fuel injection system

The system is designed to achieve an optimal injection of high-pressure fuel by means of computerized control, thereby bringing close to complete combustion to help control particulate matter (PM) emissions. While this technology is already used in current engines, the new system uses higher-pressure fuel injection, thereby further helping to reduce both PM emissions and fuel consumption over the entire engine power range.

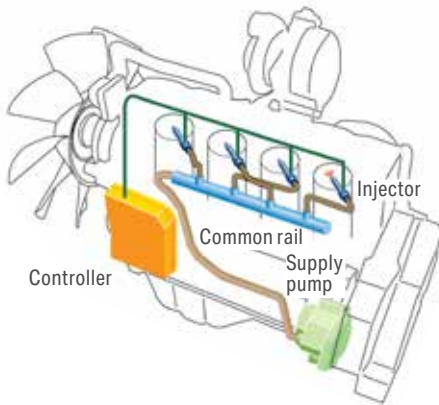

Advanced electronic control system

The electronic control system performs high-speed processing of signals from sensors installed in the vehicle and engine. This promotes better control of the equipment under virtually any condition. Engine condition information is displayed via an on-board network on the monitor inside the cab. Furthermore, Komtrax helps customers use this information to keep up with maintenance needs.

Redesigned combustion chamber at top of piston

The combustion chamber at the top of the piston has a new shape designed to improve combustion and further help control NOx, PM, fuel consumption and noise.

Auto idle shutdown function

Komatsu auto idle shutdown automatically shuts the engine down after idling for a set period of time to help reduce unnecessary fuel consumption and exhaust emissions. The amount of time before the engine is shutdown can be easily programmed from 5 to 60 minutes.

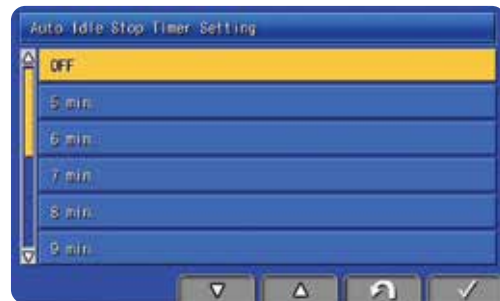

Productivity and fuel economy features

Hydrostatic transmission (HST) control system

HST control system

The HST controller monitors engine output and work load. It controls HST pump and motor displacement and is engineered to the optimum speed and drawbar pull. Full power to both tracks during turns or counter-rotation makes the D39EX/EXi/PX/PXi-24 extremely maneuverable.



Fuel efficiency

The efficient HST control system can help reduce fuel consumption.

Fuel consumption reduced by up to **5%**

Compared with D39EXi/PXi-23 in P mode
Based on typical work pattern collected via Komtrax

Hydraulically driven cooling fan

The engine cooling fan's speed is electronically controlled. Fan speed depends on engine coolant and oil temperatures. The fan will only rotate as fast as is necessary to adequately cool the machine's fluid. This system works to support fuel efficiency, helps control operating noise levels and generally will require less horsepower than a belt-driven fan.

Selectable working mode

P mode is the mode designed for powerful operation and maximum production. E mode is designed for general dozing applications and providing adequate speed and power while saving energy. For fuel usage reduction and energy savings, the monitor panel allows the operator to easily switch between working modes, depending on working conditions.

P mode (power mode)

With P mode, the engine outputs its full power, allowing the machine to perform work requiring large production, heavy-load and uphill work.

E mode (economy mode)

With E mode, the engine outputs enough power for the work without delivering unnecessary power. This mode enables energy saving operation and is designed for work on hard or rough surfaces that often cause shoe slip and work not requiring as much power, such as downhill dozing, leveling and light-load work.

Productivity and fuel economy features

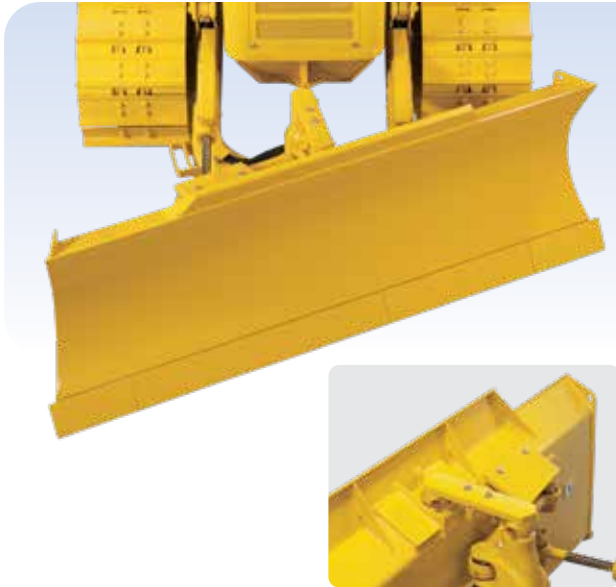

PAT dozer with adjustable pitch

A power angle power tilt dozer blade with adjustable blade pitch system is available on the D39EX/EXi/PX/PXi-24. The hydraulic blade tilt and angling function are designed to expand versatility and productivity in a variety of applications.

Excellent blade visibility

The D39EX/EXi/PX/PXi-24 incorporates Komatsu's super-slant nose design. Komatsu's innovative design provides excellent blade visibility engineered for improved machine control and increased efficiency and productivity.

Looking for a clear line of site? Let us help you see what you're missing!

Features:

- Rear-mounted radiator
- Enhanced cab-forward design with integrated ROPS
- Super slant-nose engineering

Benefits:

- **Enhanced visibility:** Rear radiator placement allows for a lower front height
- **Operator confidence:** Enhanced field of view facilitates proper operation
- **Comfortable:** Superior cab-forward design for a balanced ride

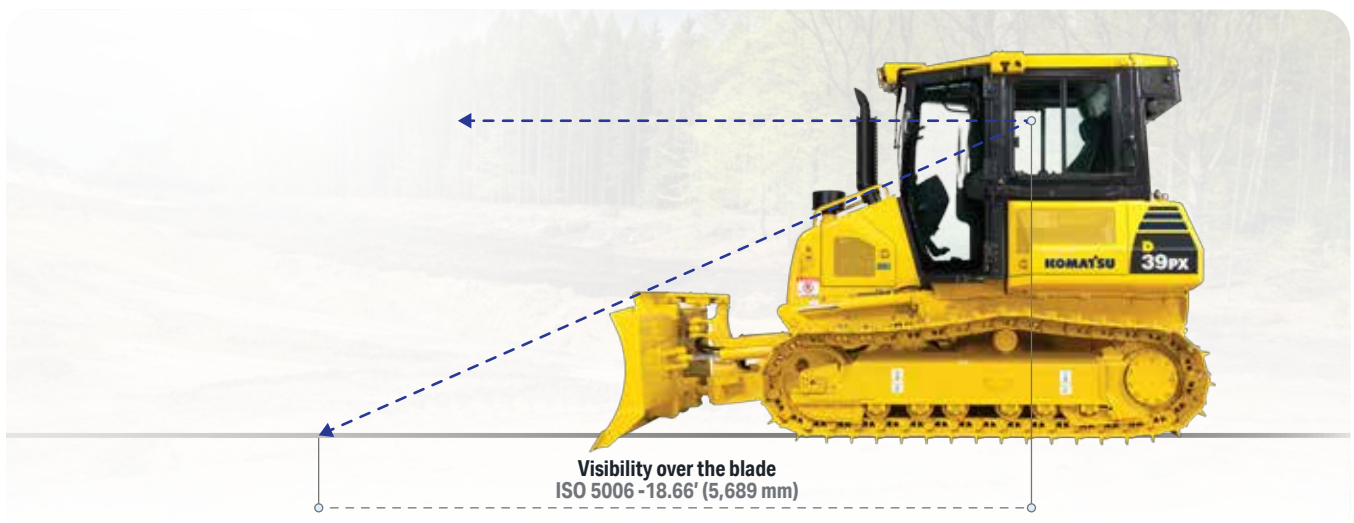

Control features



Palm Command Control System (PCCS) levers

Komatsu's ergonomically designed PCCS handles create an operating environment designed for complete operator control.

PCCS

The low-effort PCCS joystick controls directional movements, including machine travel speed as well as counter-rotation.

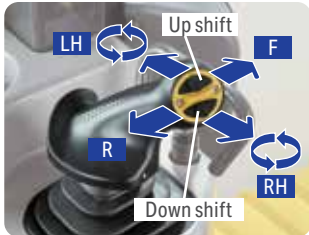

Electronic controlled hydraulic system

Electronic controlled palm commanded joystick in engineered for precise blade control. New blade angling switch operation provides easy and predictable blade control.

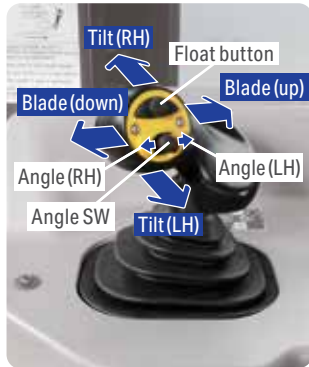

HST with electronic control

The D39EX/EXi/PX/PXi-24 is equipped with Komatsu-designed HST that allows for quick-shift or variable speed selection. The HST consists of dual-path closed-circuits, with two variable displacement piston pumps and two variable displacement travel motors. Hydrostatic steering eliminates the need for steering clutches and brakes, providing smooth, powerful turns. Fully electronic control provides automatic shifting and enabling smooth control. Engine speed is controlled using an electronic fuel control dial.

One-pedal design (decelerator/brake pedal) controls speed during operation

Machine operation is simple because brake function has been integrated into the decelerator pedal. Machine travel speed can be controlled using one pedal. The pedal function can be changed by a mode selector switch.



Decelerator mode: The pedal modulates engine rpms and vehicle travel speed. It can be used for all applications.

Brake mode: The pedal modulates vehicle travel speed while maintaining high-engine speed. This mode can be helpful to maintain work-equipment speed, while using the brake function.

Working environment

Integrated ROPS (ISO 3471) cab

The D39EX/EXi/PX/PXi-24 has an integrated ROPS (ISO 3471) cab with Bluetooth radio and LED worklights. High rigidity and superb sealing performance work to sharply reduce noise and vibration for the operator and discourage dust from entering the cab. In addition, side visibility is enhanced because external ROPS (ISO 3471) structure and posts are not required.



Comfortable ride with cab damper mounting

The D39EX/EXi/PX/PXi-24's cab mount uses a cab damper system that provides excellent shock and vibration absorption. The silicon-oil-filled cab damper mount helps to isolate the cab from the machine body, suppressing vibration and designed to provide quiet, comfortable operating environment.

Auxiliary input jack and two DC12-volt electrical outlets

By connecting an auxiliary device to this plug input, the operator can play audio from a mobile device through the machine's sound system. Two DC12-volt electrical outlets can be used as a power source for radio equipment or others.



Two DC12 V electrical outlets

Auxiliary input jack

Comfortable ride with heated operator seat

The operator seat has adjustable lumbar support, tilt and an electric heater. It is easy to adjust to the operator's shape and comfortable operation is possible in a variety of conditions. Also, the seat heat makes it possible to work comfortably in the winter.



Additional operator convenience equipment

Rearview monitor system

On the large LCD color monitor, the operator can view, through one camera, areas directly behind the machine. This camera can be synchronized with reverse operation.



Secondary engine shutdown switch

A new secondary switch has been added at the side of the front console to shut down the engine.



Technology features



Large multilingual, high-resolution LCD monitor

A large, user-friendly color monitor provides easy-to-understand information for the operator. Excellent screen visibility is achieved with a high-resolution LCD monitor that is easy to read at various angles and under various lighting conditions. Simple and easy-to-operate switches and function keys facilitate multi-function operations. The monitor displays data in 26 languages.



Multi-monitor with troubleshooting function to control downtime

Various meters, gauges and warning functions are centrally arranged on the multi-monitor. The monitor helps simplify start-up inspection and promptly warns the operator with a lamp and buzzer if any abnormalities occur. In addition, warning indicators are displayed in four levels to alert the operator of potential issues. Replacement times for required PM services are also indicated.



Energy saving operation

Ecology guidance

In order to support efficient operation, the following four messages are displayed for fuel saving operation. These can be displayed by the operator, if desired.

- 1) Avoid excessive engine idling
- 2) Use economy mode to save fuel
- 3) Avoid hydraulic relief pressure
- 4) Avoid over load



Ecology gauge

To help the operator perform in an environmentally conscious way and help control energy consumption, an easy-to-read "ecology gauge" is displayed on the left of the multi-monitor screen.

Fuel consumption display

Average fuel consumption during the day is displayed and updated every 10 seconds.

Ecological operation report for assistance

My Komatsu makes it easy to collect, visualize and monitor telematics data from both Komatsu machines and other OEM machines so that you can make the best operation and management decisions. Location, actual hours worked, fuel consumption, maintenance monitoring, load frequency and more are displayed on easy-to-read dashboards. The new D39EX/EXi/PX/PXi-24 models add the following new information to drive fuel consumption reduction:



- Guidance to help control fuel consumption
- Ecological operation report
- Operating hours by operation mode (E or P mode)
- Service information for U.S. EPA Tier 4 Final (regeneration information)

Reliability and maintenance features

Excellent reliability and durability

Parallel Link Undercarriage System (PLUS)

Komatsu's PLUS rotating bushing design helps control downtime, promotes longer wear and helps to lower undercarriage maintenance costs. Rotating bushings mitigate the cost and downtime for bushing turns, and strengthened rollers and links are designed to increase wear life. With PLUS, individual links can be replaced with common track tools.

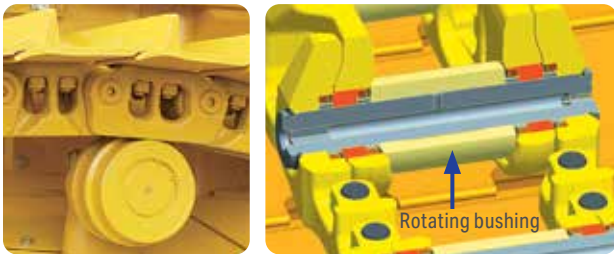

Modular design

One of the design goals behind the creation of the D39EX/EXi/PX/PXi-24 was to manufacture a more durable machine. This was achieved by reducing component complexity and using a strong modular design allows for increased serviceability and durability.



Self-adjusting idler support

The self-adjusting idler support is engineered to provide constant and even tension on idler guide plates, helping to reduce noise and vibration and driving longer undercarriage life.



Easy maintenance

Planned maintenance and daily checks are the only way to maintain long service life from equipment. That's why Komatsu designed the D39EX/EXi/PX/PXi-24 with conveniently located maintenance points to make necessary inspections and maintenance quick and easy.

Rear, hydraulically driven, swing-up fan

The D39EX/EXi/PX/PXi-24 utilizes a swing-up fan with a gas strut-assisted lift system to provide easy access to the (side-by-side) radiator, oil cooler and charge air cooler. The hydraulic fan has a cleaning mode which enables the fan to rotate in the reverse direction to help clear off objects that are restricting air flow.



Komatsu helps you bring it all together

Get the most out of your fleet with My Komatsu

We've designed a portal that makes it easy to collect, visualize and monitor data for both Komatsu machines and other OEM machines. My Komatsu also gives you one easy source for accessing manuals and purchasing parts for your machines.

- Quickly collect, view and manage intuitive data displays in one location
- Help keep costs under control
- Benchmark machine performance and track fuel consumption
- Monitor for theft and unauthorized use
- Receive timely maintenance alerts



My Komatsu, our comprehensive portal, analyzes telematics data from your on-machine technology — Komtrax and Komtrax Plus, or from other OEMs — and displays it on easy-to-read dashboards. Now you can get the powerful analytics you need to manage your costs and enhance your fleet's efficiency without a complicated process or expensive third-party solutions.



Data
Telematics data is generated by on-machine technology.



Storage
Telematics data flows into data storage. ISO 15143-3 (AEMP 2.0) facilitates the extraction and raw data to your choice of databases.



Connection
Choose how you want to connect and view your data. Go to multiple systems, send to a third party, or easily connect it all through My Komatsu.



Analytics
My Komatsu connects telematics data from Komatsu and non-Komatsu equipment and creates powerful analytics dashboard views.

mykomatsu.komatsu

Get more from an IMC machine with Smart Construction

You can have more control over your projects, efficiency and profitability when data is easily shared, replicated, updated and analyzed. That's what Smart Construction software, services and solutions are all about.



An IMC dozer is capable of dozing to plan with incredible precision and efficiency when working off a 3D design.

Have paper plans turned into digital 3D design files with our **Smart Construction Design** service.

Transfer files wirelessly to any cellular connected machine or data collector — from almost anywhere — with **Smart Construction Remote**, saving hours of time. You can also review near real-time machine data with a connected phone or computer.



As a dozer tracks, it tracks as-built data. **Smart Construction**, a productivity tracking, site visualization and site management tool can easily quantify production and easily report to and invoice clients.

We can help you implement these solutions and even train your staff to use them. Technology solution experts and trainers are available by phone, online or at your job site to help you thrive on your digitalization journey.

komatsu.com/smart-construction

D39EX/EXi/PX/PXi-24

Komatsu maintenance and repair programs

Simplify the complexities of machine owning and operating costs and enhance the value of your equipment with Komatsu's tiered maintenance and repair offerings. Manage your active coverage programs through the My Komatsu customer interface and take advantage of attractive financing options.

- Solutions that fit your needs and ease your mind
- Fixed maintenance and repair costs for the life of the contract
- National coverage



Komatsu Care Complimentary

Complimentary maintenance

Our complimentary scheduled maintenance program for the first three years or 2,000 hours, whichever occurs first.

Komatsu Care Plus

Extended maintenance

A continuation of the Komatsu Care program. Along with regularly scheduled maintenance and national distributor coverage, you get a variety of added benefits.

Komatsu Care Plus II

Extended maintenance and repair

Everything in the Komatsu Care Plus program bundled with comprehensive repair coverage for qualifying repairs.

Komatsu Care Plus III

Extended maintenance, repair and consumables

A comprehensive program that simplifies your equipment's total cost of ownership with a fixed cost per hour for qualifying repairs and replacements.

Komatsu Care Advantage Warranty

Extended warranty

Protect your equipment in the event a covered component fails due to a defect in material or workmanship. Repairs are performed by Komatsu-trained experts using Komatsu genuine parts.

komatsu.com/maintenance-repair

Komatsu Financial

Financial services built for your business success.

komatsu.com/financing

Komatsu Genuine Parts

Engineered to help extend the life of your Komatsu machine. Now available on the My Komatsu parts store.

komatsu.com/parts

Komatsu training

Comprehensive training support — virtually, at our facility or where most convenient.

komatsu.com/training



Engine

| | | |
|---------------------|-----------------------------------------------------|--|
| Model | Komatsu SAA4D95LE-7* | |
| Type | 4-cycle, water-cooled, direct injection | |
| Aspiration | Variable flow, turbocharged, air-to-air aftercooled | |
| Number of cylinders | 4 | |
| Bore x stroke | 3.75 in x 4.52 in (95 mm x 115 mm) | |
| Piston displacement | 199 in ³ (3.26 L) | |
| Governor | All-speed, electronic | |
| Horsepower | | |
| SAE J1995 | Gross: 107 HP (79 kW) | |
| ISO 9249/SAE J1349 | Net: 105 HP (78 kW) | |
| Rated rpm | 2,200 rpm | |
| Fan drive type | Hydraulic | |
| Lubrication system | | |
| Method | Gear pump, force lubrication | |
| Filter | Full-flow | |

*EPA Tier 4 Final emissions certified

Hydrostatic transmission

Dual-path, hydrostatic transmission provides infinite speed changes up to 5.3 km/h 8.5 mph. The variable capacity travel motors allow the operator to select the best speed to match specific jobs. Travel control lock lever and neutral switch.

| Travel speed (quick shift mode)* | Forward | | Reverse |
|-------------------------------------|----------------------|----------------------|----------------------|
| | 1st | 0-3.4 km/h 0-2.1 mph | 0-4.1 km/h 0-2.5 mph |
| 2nd | 0-5.6 km/h 0-3.5 mph | 0-6.5 km/h 0-4.0 mph | |
| 3rd | 0-8.5 km/h 0-5.3 mph | 0-8.5 km/h 0-5.3 mph | |

| Travel speed (variable mode) | Forward | | Reverse |
|---------------------------------|---------|----------------------|----------------------|
| | | 0-8.5 km/h 0-5.3 mph | 0-8.5 km/h 0-5.3 mph |

*Quick shift speeds are adjustable in the monitor.

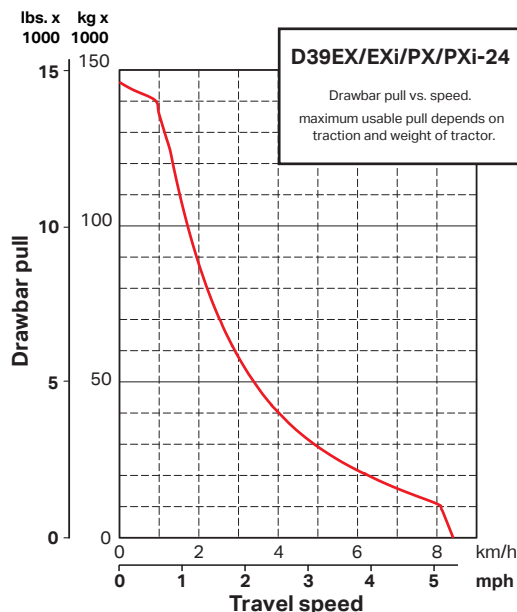

Final drives

In-shoe mounted, axial-piston-type travel motors, with integrated two-stage planetary gear reduction. Compact in-shoe mount helps control risk of damage by debris. Bolt-on sprocket ring with triple labyrinth seal design.

Steering system

Palm Command Control System (PCCS) joystick control for all directional movements. Pushing the joystick forward results in forward machine travel, while pulling it rearward reverses the machine. Simply tilt the joystick to the left or right to make a turn. Tilting the joystick fully to the left or right activates counter-rotation.

Hydrostatic Transmission (HST) provides smooth powerful turns. Fully electronic control enables smooth control that can be adjusted in the monitor. The PCCS utilizes shift buttons to increase and decrease speed.

Minimum turning radius*

| | |
|--------------|---------------|
| D39EX/EXi-24 | 2.2 m (87 in) |
| D39PX/PXi-24 | 2.4 m (94 in) |

*As measured by track marks on the ground at pivot turn.

Undercarriage

| | | | |
|------------------------------------------------------------------------------------------------------------------------------------------------------------------------------------------|------------------------------------------------|--|--|
| Suspension | Rigid type | | |
| Track roller frame | Monocoque, large section, durable construction | | |
| Rollers and idlers | Lubricated track rollers | | |
| Sealed and lubricated track...Track tension easily adjusted w/grease gun | | | |
| Parallel Link Undercarriage System (PLUS) with lubricated rotating bushings for extended system wear life and lower maintenance costs. Track tension is adjusted easily with grease gun. | | | |

| | D39EX/EXi-24 | D39PX/PXi-24 narrow | D39PX/PXi-24 wide |
|----------------------------------------------------|------------------------------------|----------------------|----------------------|
| Number of track rollers (each side) | 6 | 7 | 7 |
| Type of shoes (standard) | Single grouser | Single grouser | Single grouser |
| Number of shoes (each side) | 39 | 39 | 39 |
| Grouser height | mm in | 47 1.9" | 47 1.9" |
| Shoe width (standard) | mm in | 510 20" | 635 25" |
| Ground contact area | cm ² in ² | 23919 3,707 | 29782 4,616 |
| Ground pressure (with dozer, ROPS cab) (ISO 16754) | kPa kgf/cm ² psi | 36.1 0.37 5.24 | 30.1 0.31 4.39 |
| Track gauge | mm ft. in | 1620 5'4" | 1810 5'11" |
| Length of track on ground | mm ft. in | 2345 7'8" | 2345 7'8" |

Service refill capacities

| | | |
|---------------------------------|-------|-------------|
| Coolant | 34 L | 9.0 US gal |
| Fuel tank | 190 L | 50.2 US gal |
| Engine oil | 11 L | 2.9 US gal |
| Hydraulic tank | 64 L | 17 US gal |
| Final drive (each side) | 3.5 L | 0.9 US gal |
| Diesel Exhaust Fluid (DEF) tank | 10 L | 2.6 US gal |

D39EX/EXi/PX/PXi-24

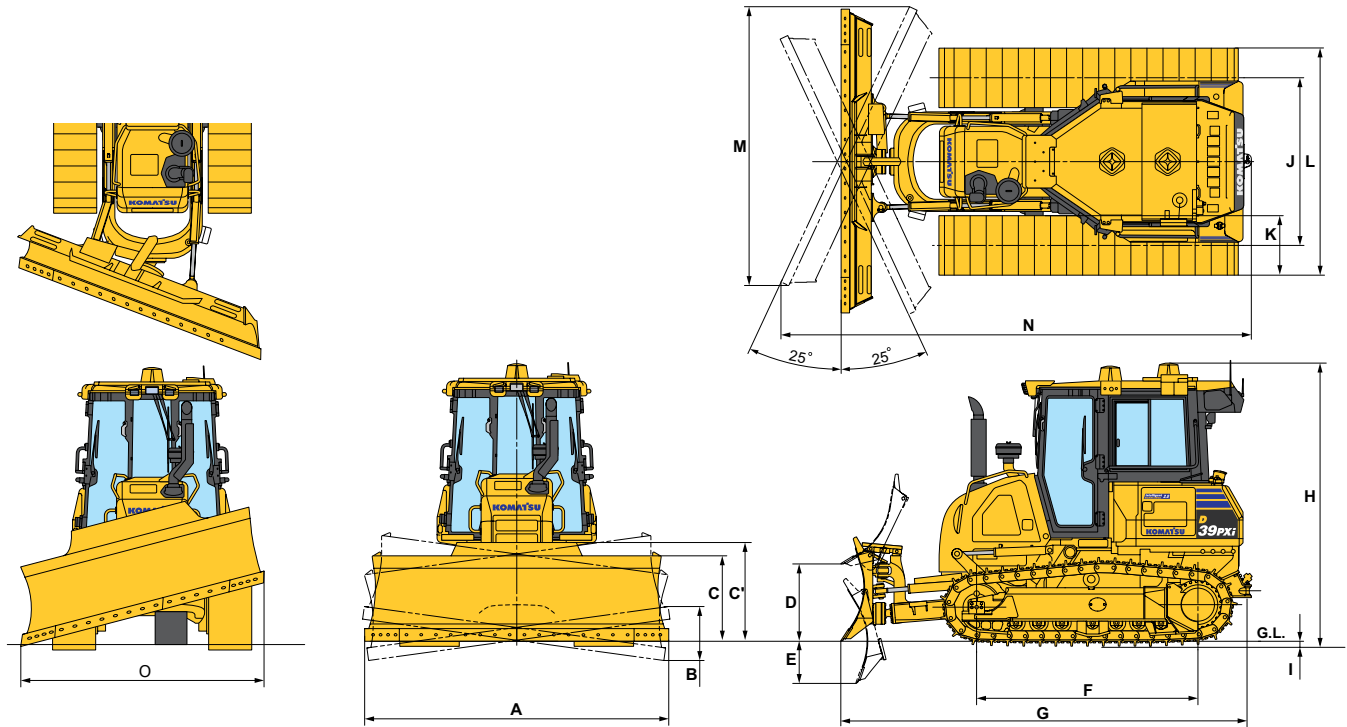

Dimensions

| | D39EX/EXi-24 | | D39PX/PXi-24 | |
|------------------|--------------|----------|--------------|----------|
| A | 8'11" | 2,710 mm | 10'8" | 3,250 mm |
| B | 1'2" | 365 mm | 1'5" | 440 mm |
| C | 3'3" | 980 mm | 3' | 910 mm |
| C1 | 3'8" | 1,120 mm | 3'7" | 1,105 mm |
| D | 2'8" | 820 mm | 2'8" | 820 mm |
| E | 1'5" | 440 mm | 1'5" | 440 mm |
| F | 7'8" | 2,345 mm | 7'8" | 2,345 mm |
| G | 14'5" | 4,385 mm | 14'5" | 4,385 mm |
| H | 9'11" | 3,010 mm | 9'4" | 2,850 mm |
| I | 1.9" | 47 mm | 1.9" | 47 mm |
| J | 5'4" | 1,620 mm | 5'11" | 1,810 mm |
| K | 1'6" | 460 mm | 2'1" | 635 mm |
| L | 6'10" | 2,080 mm | 8'2" | 2,445 mm |
| M | 8'2" | 2,495 mm | 9'10" | 2,990 mm |
| N | 16'1" | 4,910 mm | 16'6" | 5,020 mm |
| O | 8'1" | 2,475 mm | 9'8" | 2,940 mm |
| Ground clearance | | | 15" 390 mm | |

Operating weight (approximate)

Tractor weight

Including ROPS cab, U frame for power angle tilt dozer, rated capacity of lubricant, coolant, full fuel tank, operator, and standard equipment.

| | |
|-----------|------------------------|
| D39EX-24 | 19,379 lbs. (8,790 kg) |
| D39EXi-24 | 19,510 lbs. (8,850 kg) |
| D39PX-24 | 20,150 lbs. (9,140 kg) |
| D39PXi-24 | 20,282 lbs. (9,200 kg) |

Operating weight

Including power angle tilt dozer, ROPS cab, operator, standard equipment, rated capacity of lubricant, hydraulic control unit, coolant, and full fuel tank.

| | |
|-----------|-------------------------|
| D39EX-24 | 21,891 lbs. (9,930 kg) |
| D39EXi-24 | 22,068 lbs. (10,010 kg) |
| D39PX-24 | 22,817 lbs. (10,350 kg) |
| D39PXi-24 | 22,950 lbs. (10,410 kg) |

Hydraulic system

Closed-Center Load Sensing System (CLSS) designed for precise and responsive control, and for efficient simultaneous operation.

Hydraulic control unit

All spool control valves externally mounted remote to the hydraulic tank.
Piston-type hydraulic pump with capacity (discharge flow) of 99 ltr/min 26.2 US gal/min at rated engine rpm.

| | | |
|--------------------------------------------------|---------------------------------------------|--------------|
| Relief valve setting | 27.4 MPa 280 kg/cm ² (3,974 psi) | |
| Hydraulic cylinders | Double-acting, piston type | |
| | Number of cylinders | Bore |
| Blade lift | 2 | 75 mm (3.0") |
| Blade tilt | 1 | 90 mm (3.5") |
| Blade angle | 2 | 80 mm (3.2") |
| Hydraulic oil capacity (refill): | | |
| Power angle tilt dozer | 64 L | 17 US gal |
| Control valves | | |
| 3-Spool control valve for power angle tilt dozer | | |
| Positions | | |
| Blade lift | Raise, hold, lower, and float | |
| Blade tilt | Right, hold, and left | |
| Blade angle | Right, hold, and left | |
| Additional control valve required for ripper | | |
| Positions | | |
| Ripper lift | Raise, hold, and lower | |



Dozer equipment

| | Overall length with dozer* ft. in mm | Blade capacity yd ³ m ³ | Blade width x height ft. in mm | Max. lift above ground ft. in mm | Max. drop below ground ft. in mm | Max. tilt adjustment ft. in mm | Blade angle |
|--------------------------------|-----------------------------------------|--------------------------------------------------|-----------------------------------|-------------------------------------|-------------------------------------|-----------------------------------|-------------|
| D39EX/EXi-24 Standard blade | 14'5" 4,385 mm | 2.89 yd ³ 2.21 m ³ | 8'11" x 3'3" 2,710 mm x 980 mm | 2'8" 820 mm | 1'5" 440 mm | 1'3" 385 mm | 25° |
| D39PX/PXi-24 Standard blade | 14'5" 4,385 mm | 3.14 yd ³ 2.40 m ³ | 10'8" x 3' 3,250 mm x 910 mm | 2'8" 820 mm | 1'5" 440 mm | 1'5" 440 mm | 25° |
| D39PX/PXi-24 Narrow blade | 14'5" 4,385 mm | 2.90 yd ³ 2.22 m ³ | 9'9" x 3' 2,980 mm x 910 mm | 2'8" 820 mm | 1'5" 440 mm | 1'4" 405 mm | 25° |

*Including hitch

Blade capacities are based on the ISO recommended practice 9246.
Use of high-tensile-strength steel in moldboard for strengthened blade construction.

| Standard equipment for base machine* | D39 | D39i |
|-------------------------------------------------------------------------------------------------------------------------------------------------------------------------------------------------|-----|------|
| Accumulator for Electric Proportional Control (EPC) | • | • |
| Air cleaner, dry, double element type with caution lamp on monitor | • | • |
| Air conditioner (A/C) | • | • |
| Air inlet | • | • |
| Alternator, 24 V/85 A | • | • |
| Back-up alarm | • | • |
| Batteries, large capacity 24 V/92 Ah | • | • |
| Cab accessories | | |
| – 12 V × 2 power supply | | |
| – Cup holder | | |
| – Rear view mirror | • | • |
| – Rear view monitor system | | |
| – Bluetooth/USB compatible radio with remote AUX plug (3.5 mm) | | |
| Crankcase guard and underguard | • | • |
| Decelerator/brake pedal (single pedal) | • | • |
| Electronically controlled Hydrostatic Transmission (HST) with quick-shift and variable speed settings | • | • |
| Electronic monitor panel with on-board diagnostics | • | • |
| Engine hood and side panels | • | • |
| Engine, Komatsu SAA4D95LE-7, gross output of 80 kW 107 HP, direct injection, water-cooled turbocharged, air-to-air aftercooler, cooled EGR, EPA Tier 4 Final and EU Stage 4 emissions certified | • | • |
| Fan, hydraulic driven, electronic control | • | • |
| Filler cap locks and cover locks | • | • |
| Foot rest, high mounted | • | • |
| Fuel pre-filter (10 micron) and fuel filter (2 micron) | • | • |
| Grease gun holder | • | • |
| High altitude arrangement (No fuel adjustment up to 2300 m) | • | • |
| Horn | • | • |
| Hydraulics for PAT dozer | • | • |
| Intake pipe with precleaner | • | • |
| Large high-resolution LCD | • | • |
| LED worklights | • | • |
| Lunch box holder | • | • |
| Marks and plates, English | • | • |
| New operator identification system | • | • |
| Palm Command Control System (PCCS) with electronic control for travel control | • | • |
| Palm Command Control System (PCCS) with EPC for blade control | • | • |
| Power turn with counter rotation | • | • |
| Pullhook, front | • | • |
| Radiator guard grid | • | • |

| | D39 | D39i |
|-------------------------------------------------------------------------------------|-----|------|
| Radiator reserve tank | • | • |
| Real-time DEF monitoring | • | • |
| Rear-hinged radiator guard | • | • |
| Reverse travel speed presets | • | • |
| ROPS cab, meets ISO 3471, SAE J/ISO 3471 ROPS standards, and ISO 3449 FOPS standard | • | • |
| Seat belt, 3" (76 mm) retractable | • | • |
| Seat, air suspension, fabric, heated, low back, headrest | • | • |
| Starting motor, 24 V/4.5 kW | • | • |
| Self adjusting roller | • | • |
| Sprockets, bolt-on | • | • |
| Sprocket inner guard | • | • |
| Track roller guards, end section | • | • |
| Track shoe assembly (PLUS) | • | • |
| – Heavy-duty lubricated rotary bushing | | |
| D39EX/EXi-24: 20" (510 mm) single grouser shoe | • | • |
| D39PX/PXi-24: 25" (635 mm) single grouser shoe | • | • |
| Triple labyrinth final drive | • | • |
| Water separator | • | • |
| Shovel holder | • | • |

| Optional equipment | D39 | D39i |
|-------------------------------------------|-----|------|
| Dozer assembly | ○ | ○ |
| Hitch | ○ | ○ |
| Hydraulics for rear equipment | ○ | ○ |
| Track roller guard, full length | ○ | ○ |
| Multi-shank scarifier | | |
| – Weight 1,036 lbs. (470 kg) | | |
| – Beam length 62" (1,569 mm) | | |
| – Maximum lift above ground 15" (389 mm) | ○ | ○ |
| – Maximum digging depth 13" (336 mm) | | |
| – Number of shanks 3 | | |
| 27.5" (700 mm) single grouser (PX) (PLUS) | ○ | ○ |
| IMC 2.0 2D laser kit | - | ○ |

| Allied manufacturer's attachments (shipped loose) | D39 | D39i |
|---------------------------------------------------|-----|------|
| Guarding-Komatsu (Ken Garner) | | |
| – Front sweeps 584 lbs. (229 kg) | | |
| – Hinged cab side screens 97 lbs. (44 kg) | ○ | ○ |
| – Hinged cab rear screen 95 lbs. (43 kg) | | |
| – Poly panel door inserts 91 lbs. (41 kg) | | |
| Hydraulic winch - Allied H4AT 1,510 lbs. (685 kg) | ○ | ○ |
| Fairlead, four roller | ○ | ○ |
| Drawbar | ○ | ○ |
| Arch, four roller | ○ | ○ |

| | | |
|------------------------------------------------------------------------------------|--------------------|---|
| *Dozer assembly and rear-mounted equipment are not included in base machine price. | Standard equipment | • |
| | Optional equipment | ○ |
| | Not applicable | - |

Product designs, specifications and/or data in this document are provided for informational purposes only and are not warranties of any kind. Product designs and/or specifications may be changed at any time without notice. The only warranties that apply to sales of products and services are Komatsu's standard written warranties, which will be furnished upon request.

Komatsu and other trademarks and service marks used herein are the property of Komatsu Ltd. or its subsidiaries, or the respective owners or licensees.

KOMATSU

komatsu.com

