



WEIGHT CHANGES

Tires or attachments	Operating weight		Tipping load straight Standard Boom		Tipping load full turn Standard Boom		Width over tires		Ground clearance		Change in vertical dimensions	
	kg	lb	kg	lb	kg	lb	mm	ft in	mm	ft in	mm	ft in
29.5-25-22PR(L-3)	0	0	0	0	0	0	3190	10'6"	450	1'6"	0	0
Install additional counterweight	+900	+1985	+1865	+4110	+1645	+3625						
Air conditioner	+65	+145	+33	+75	+30	+240						
Emergency steering	+70	+155	+65	+145	+55	+120						
Lock-up clutch torque converter	+45	+100	+60	+130	+50	+110						
ECSS (Electronically Controlled Suspension System)	+120	+265	+13	+30	+11	+24						



STANDARD EQUIPMENT

- 2-spool valve for boom and bucket controls
- Alternator, 75 A/24 V
- Auto shift transmission with mode select system
- Back-up alarm
- Back-up lamp
- Batteries, 170 Ah/12 V x 2
- Counterweight
- Directional signal
- Engine, Komatsu SAA6D140E-5 diesel
- Engine pre-cleaner with extension
- Engine shut-off system, electric
- EPC fingertip control levers with automatic leveler and positioner
- Floormat
- Front fender
- Hard water area arrangement (corrosion resister)
- Hydraulic-driven fan with reverse rotation
- Lift cylinders and bucket cylinder
- Main monitor panel with EMMS (Equipment Management Monitoring System)
- Radiator mask, lattice type
- Rearview mirror for cab
- Rear window washer and wiper
- ROPS/FOPS cab
- Seat, air-suspension type with reclining
- Service brakes, wet disc type
- Starting motor, 11.0 kW/24 V
- Steering wheel, tiltable
- Sun visor
- Tires (29.5-25-22PR tubeless) and rims
- Transmission, 4 forward and 4 reverse



OPTIONAL EQUIPMENT

- 12V converter
- Additional counterweight
- Air conditioner
- Alternator, 90A/24V
- AM/FM radio
- AM/FM stereo radio cassette
- Automatic greasing
- Batteries, 220 Ah/12V x 2
- Battery disconnect switch
- Brake cooling system
- Bucket teeth (bolt-on type)
- Bucket teeth (tip type)
- Cab heater and defroster
- Cold area arrangement (-30 thru 40°C)
- Cutting edge (bolt-on type)
- ECSS (Electronically Controlled Suspension System)
- Emergency steering (SAE)
- Fire extinguisher
- FNR directional change switch
- Fuel quick coupler
- High lift boom
- In-line filter
- Joystick steering
- Load meter, new type
- Lock-up clutch torque converter
- Ordinary spare parts
- Power train guard
- Quick nipple for hydraulic
- Sandy area arrangement
- Seat, air suspension with automatic weight adjustment
- Seat belt
- Segment edges
- Tool kit
- Vandalism protection kit
- Limited slip differential (F&R)

www.Komatsu.com

Printed in Japan 200601 IP.SIN (10)

KOMATSU®

CEN00067-00

Materials and specifications are subject to change without notice
KOMATSU is a trademark of Komatsu Ltd. Japan

HORSEPOWER

Gross: 266 kW 357 HP @ 1900 rpm

Net: 263 kW 353 HP @ 1900 rpm

BUCKET CAPACITY

4.3-5.6 m³ 5.6-7.3 yd³

KOMATSU®

WA500-6

ecot3

WA 500



Photo may include optional equipment.

WHEEL LOADER

WALK-AROUND

HORSEPOWER
 Gross: 266 kW 357 HP @ 1900 rpm
 Net: 263 kW 353 HP @ 1900 rpm

BUCKET CAPACITY
 4.3–5.6 m³ 5.6–7.3 yd³

High Productivity & Low Fuel Consumption

- High performance SAA6D140E-5 engine
- Low fuel consumption
- Dual-mode engine power select system
- Automatic transmission with shift timing select system
- Lock-up Torque Converter (Optional)
- Variable displacement piston pump & CLSS
- Increased bucket capacity
- Long wheelbase

See pages 4 and 5.

Excellent Operator Environment

- Automatic transmission with ECMV
 - Low-noise designed cab
 - Electronic controlled transmission lever
 - Variable transmission cut-off system
 - Engine RPM set system with auto decel
 - “EPC” (Electronic Pilot Control) levers
 - Pillar-less large ROPS/FOPS integrated cab
 - Easy entry/exit, rear-hinged door
 - Telescopic / tilt steering column
- See pages 8 and 9.

Increased Reliability

- Reliable Komatsu designed and manufactured components
- Sturdy main frame
- Maintenance-free, fully hydraulic, wet disc service and parking brakes
- Hydraulic hoses use flat face O-ring seals

See page 6.

- Cathion electrodeposition process is used to apply primer paint
- Powder coating process is used to apply main structure paint
- Sealed DT connectors for electrical connections



GALEO

Building on the technology and expertise Komatsu has accumulated since its establishment in 1921, GALEO presents customers worldwide with a strong, distinctive image of technological innovation and exceptional value. The GALEO brand will be employed for Komatsu's full lineup of advanced construction and mining equipment. Designed with high productivity, safety and environmental considerations in mind, the machines in this line reflect Komatsu's commitment to contributing to the creation of a better world.

Genuine Answer for Land and Environment Optimization

Harmony with Environment

- Meets EPA Tier 3 and EU stage 3A emission regulations
- Low exterior noise
- Low fuel consumption

Easy Maintenance

- “EMMS” (Equipment Management Monitoring System)
- Ease of radiator cleaning
- Modular radiator core system

See page 7.

Photo may include optional equipment.

HIGH PRODUCTIVITY AND LOW FUEL CONSUMPTION



High Performance SAA6D140E-5 Engine

Electronic Heavy Duty Common Rail fuel injection system provides optimum combustion of fuel. This system also provides fast throttle response to match the machine's powerful tractive effort and fast hydraulic response.

Net: 263 kW 353 HP

Low Emission Engine

This engine meets EPA Tier 3 emission regulations and EU stage 3A emission regulations, without sacrificing power or machine productivity.

Low Fuel Consumption

The fuel consumption is reduced greatly because of the low-noise, high-torque engine and the large-capacity torque converter with maximum efficiency in the low-speed range.

Dual-Mode Engine Power Select System

This wheel loader offers two selectable operating modes—E and P. The operator can adjust the machine's performance with the selection switch.

- **E Mode:** This mode provides maximum fuel efficiency for general loading.

- **P Mode:** This mode provides maximum power output for hard digging operation or hill climb.



Dual mode engine power selection switch



The eco indicator will help an operator to promote energy saving.

Automatic Transmission with Mode Select System

This operator controlled system allows the operator to select manual shifting or two levels of automatic shifting (low, and high).

Auto L mode is for fuel saving operation with the gear shift timing set at lower speeds than Auto H mode. Therefore Auto L mode keeps the engine in a relatively low rpm range for fuel conservation while yielding adequate tractive force by depressing the accelerator pedal.



Shift mode selection switch

Lock up clutch switch (optional)

Lock-up Torque Converter (optional)

The Komatsu designed lock-up torque converter provides increased production efficiency, reduced cycle times and optimum fuel savings in load & carry or hill-climb operations. This optional feature allows the operator to activate the system on/off with a switch located on the right-side control panel.

Variable displacement piston pump & CLSS

New design variable displacement piston pump combined with the Closed-center Load Sensing System delivers hydraulic flow just as the job requires preventing wasted hydraulic pressure. Minimized waste loss contributes to better fuel economy.

- **New Variable Displacement Piston Pump:** The pump delivers only necessary amounts minimizing waste loss.

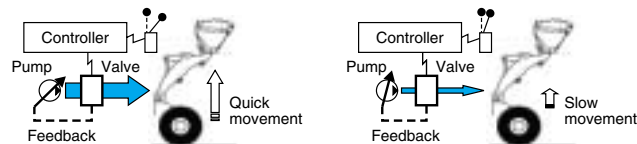

- **Fixed Displacement Piston Pump:** The pump delivers the maximum amount at any time and the unused flow is disposed.

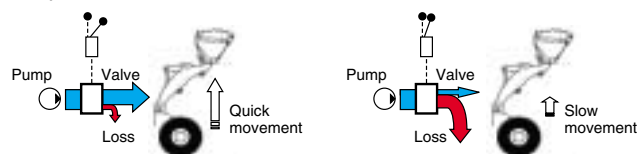

Increased Bucket Capacity matches with one class higher dump truck



The WA500 enables loading onto 32t (40 Short ton) with the standard spec whereas WA500-6 necessitates the high lift boom with the 4.5m³ bucket for it. Operator can get good visibility because of high his eye point.

Dumping Clearance: 3295 mm 10'10"
Dumping Reach: 1500 mm 4'11"
(5.6 m³ 7.3 yd³ bucket with B.O.C.)

Long Wheelbase/Articulation Angle of 40°

The widest tread in class and the long wheelbase provide improved machine stability in both longitudinal and lateral directions. Since the articulation angle is 40°, the operator can work efficiently even in the tightest job sites.

Tread	2400 mm	7'10"
Wheelbase	3780 mm	12'5"
Minimum turning radius (center of outside tire)	6430 mm	21'1"

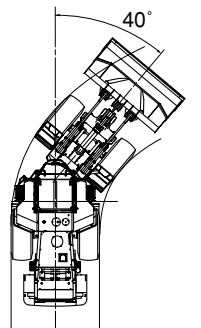

INCREASED RELIABILITY

Komatsu Components

Komatsu manufactures the engine, torque converter, transmission, hydraulic units, electric parts, on this wheel loader. Komatsu loaders are manufactured with an integrated production system under a strict quality control system.

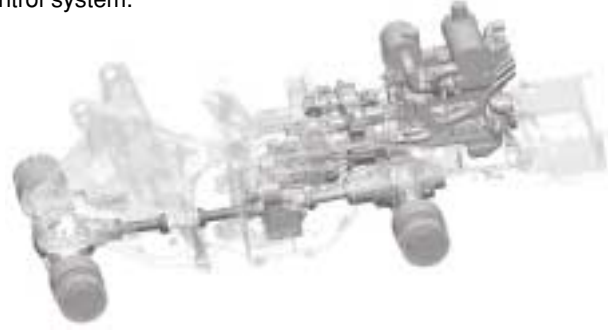

Wet multi-disc brakes and fully hydraulic braking system mean lower maintenance costs and higher reliability. Wet disc brakes are fully sealed. Contaminants are kept out, reducing wear and maintenance. Brakes require no adjustments for wear, meaning even lower maintenance. The new parking brake is also an adjustment-free, wet multi-disc for high reliability and long life.

Added reliability is designed into the braking system by the use of two independent hydraulic circuits. Provides hydraulic backup should one of the circuits fail.

Fully hydraulic brakes mean no air system to bleed, or the condensation of water in the system that can lead to contamination, corrosion, and freezing.

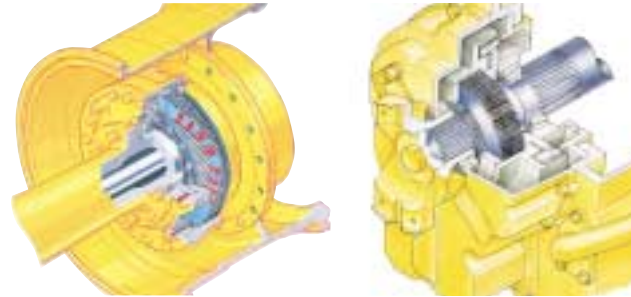

High-rigidity Frames and Loader Linkage

The front and rear frames and the loader linkage have more torsional rigidity to secure resistance against increased stress due to the use of a larger bucket.

Frame and loader linkage are designed to accommodate actual working loads, and simulated computer testing proves its strength.

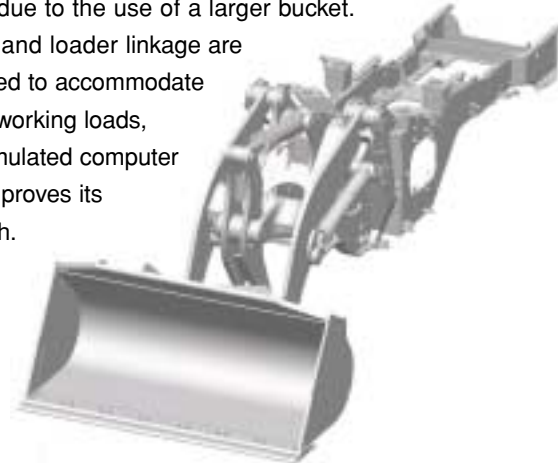

Flat Face-to-Face O-Ring Seals

Flat face-to-face O-ring seals are used to securely seal hydraulic hose connections and to prevent oil leakage. In addition, buffer rings are installed to the head side of the all-hydraulic cylinders to lower the load on the rod seals and maximize the reliability.

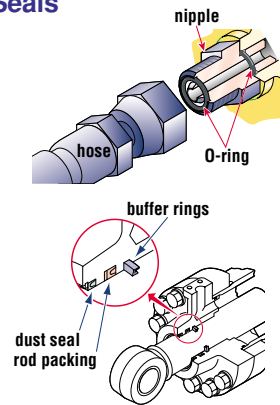

Cathion Electrodeposition Primer Paint/ Powder Coating Final Paint

Cathion electrodeposition paint is applied as a primer paint and powder coating is applied as topcoat to the exterior sheet metal parts. This process results in a beautiful rust-free machine, even in the most severe environments. Some external parts are made of plastic providing long life and high impact resistance.

Sealed DT Connectors

Main harnesses and controller connectors are equipped with sealed DT connectors providing high reliability, water resistance and dust resistance.



EASY MAINTENANCE



Photo may include optional equipment.

EMMS (Equipment Management Monitoring System)

Monitor is mounted in front of the operator for easy viewing, allowing the operator to easily check gauges and warning lights. A specially designed two-spoke steering wheel allows the operator to easily see the instrument panel.



Maintenance Control and Troubleshooting Functions

- **Action code display function:** If abnormality occurs, the monitor displays action details on the character display at the bottom center of the monitor.
- **Monitor function:** Controller monitors engine oil level, pressure, coolant temperature, air cleaner clogging, etc. If controller finds abnormalities, the error is displayed on LCD.
- **Replacement time notice function:** Monitor informs replacement time of oil and filters on LCD when replacement intervals are reached.
- **Trouble data memory function:** Monitor stores abnormalities for effective troubleshooting.

Gull-wing Type Engine Side Doors Open Wide

The operator can open and close each gull-wing type engine side door easily with the assistance of a gas spring to perform daily service checks from the ground.



Modular radiator core system

The modular radiator core is easy to replace without removing the entire radiator assembly.



Ease of Radiator Cleaning



If the machine is operating in adverse conditions, the operator can reverse the hydraulic cooling fan from inside the cab by turning a switch on the control panel.

OPERATOR ENVIRONMENT

Easy Operation

Automatic Transmission with ECMV

Automatic transmission with ECMV automatically selects the proper gear speed based on travel speed, engine speed, and other travel conditions. The ECMV (Electronically Controlled Modulation Valve) system engages the clutch smoothly to prevent lags and shocks when shifting. This system provides efficient machine operation and a comfortable ride.

● Kick-down

switch: Consider this valuable feature for added productivity. With the touch of a finger, the kick-down switch

automatically downshifts from second to first when beginning the digging cycle. It automatically upshifts from first to second when the direction control lever is placed in reverse. This results in increased rim pull for better bucket penetration and reduced cycle times for higher productivity.

- **Hold switch:** Auto shift is selected and if the operator turns on this switch when the lever is at the 3rd or 4th gear speed position, the transmission is fixed to that gear speed.

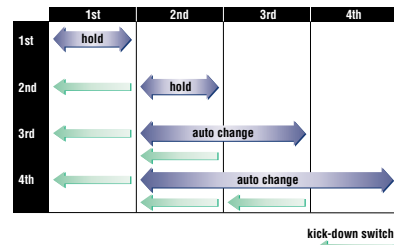

Electronically Controlled Transmission Lever



Easy shifting and directional changes with Komatsu two-lever electronic shifting. Change direction or shift gears with a touch of the fingers without removing the shifting hand from the steering

wheel. Solid state electronics and conveniently located direction and gear shift controls make this possible. Automatic shifts in ranges two through four keep production high and manual shifting at a minimum.

Variable Transmission Cut-off System

The operator can continuously adjust the transmission cut-off pressure desired for the left brake pedal using switch located on the right-side control panel. The operator can improve the working performance by setting the cut-off pressure properly depending on working condition.

- High cut-off pressure for digging operations.
- Low cut-off pressure for truck-loading operations.



- 1: Cut-off ON/OFF switch
- 2: Cut-off adjustment switch
- 3: Boom positioner switch
- 4: Bucket digging angle control switch
- 5: RPM set ON/OFF switch
- 6: RPM set adjustment switch
- 7: Semi-auto digging system
- 8: Fan reverse switch
- 9: Boom control
- 10: Bucket control

Engine RPM Set System with Auto Decel

Engine Low idle RPM can be easily preset using a push button switch. The system provides auto decel for better fuel consumption.



EPC (Electronic Pilot Control) levers

The EPC work equipment control lever is a finger controlled lever having light operating effort and short stroke. The operator can operate easily and comfortably with full adjustable large size arm rest. Combined with CLSS, this system allows following new functions for easy and efficient operation.



● Remote Boom Positioner with shockless stop

function: The highest and lowest position of the bucket can be set from cab to match of any truck body. Once the positioner is set, the bucket is smoothly stopped at desired position with no shock.

- **Remote bucket digging angle control:** The digging bucket angle can be easily set from cab to match of ground condition.

- **Semi-auto digging system (option):** Bucket tilt operation can be automatically done when digging.

Telescopic/Tilt Steering Column

The operator can tilt and telescope the steering column to provide a comfortable working position.

Comfortable Operation

Low-noise Design

Noise at operator's ear noise level : 75 dB(A)
Dynamic noise level (outside): 109 dB(A)

The large cab is mounted with Komatsu's unique ROPS/FOPS viscous mounts. The low-noise engine, hydraulically driven fan, and hydraulic pumps are mounted with rubber cushions, and the cab sealing is improved to provide a quiet, low-vibration, dustproof with pressurizing, and comfortable operating environment. Also, exterior noise is lowest in this class.



Pillar-less Large Cab

A wide pillar-less flat glass provides excellent front visibility. The wiper arm covers a large area to provide great visibility even on rainy days.

The cab area is the largest in its class providing maximum space for the operator. Increased seat slide adjustment to backward by introducing front mounted air conditioner unit.

Rear-hinged Full Open Cab Door

The cab door hinges are installed to the rear side of the cab providing a large opening angle for the operator to enter and exit. The steps are designed like a staircase, so that the operator can get on and off the cab easily.



SPECIFICATIONS



ENGINE

ModelKomatsu SAA6D140E-5
 TypeWater-cooled, 4-cycle
 AspirationTurbocharged, aftercooled, cooled EGR
 Number of cylinders6
 Bore x stroke140 mm x 165 mm 5.51" x 6.50"
 Piston displacement15.24 ltr 930 in³
 Governorall-speed, electronic
 Horsepower
 SAE J1995Gross **266 kW** 357 HP
 ISO 9249/SAE J1349*Net **263 kW** 353 HP
 Rated rpm1900 rpm
 Fan drive method for radiator coolingHydraulic
 Fuel systemDirect injection
 Lubrication system:
 MethodGear pump, force-lubrication
 FilterFull-flow type
 Air cleanerDry type with double elements and dust evacuator, plus dust indicator

*Net horsepower at the maximum speed of radiator cooling fan is 248 kW 332 HP.



TRANSMISSION

Torque converter:
 Type3-element, single-stage, double-phase
 Transmission:
 TypeFull-powershift, planetary type
 Travel speed: **km/h** mph
 Measured with 29.5-25 tires

	1st	2nd	3rd	4th
Forward	7.7 4.8	12.5 7.8	22.3 13.9	34.9 21.7
Reverse	8.6 5.3	13.0 8.1	24.8 15.4	37.5 23.3



AXLES AND FINAL DRIVES

Drive systemFour-wheel drive
 FrontFixed, full-floating
 RearCenter-pin support, full-floating, 24° total oscillation
 Reduction gearSpiral bevel gear
 Differential gearConventional type
 Final reduction gearPlanetary gear, single reduction



BRAKES

Service brakesHydraulically actuated, wet disc brakes actuate on four wheels
 Parking brakeWet disc brake
 Emergency brakeParking brake is commonly used



STEERING SYSTEM

TypeArticulated type, full-hydraulic power steering
 Steering angle40° each direction
 Minimum turning radius at the center of outside tire6430 mm 21'1"



HYDRAULIC SYSTEM

Steering system:
 Hydraulic pumpPiston pump
 Capacity120 ltr/min 31.7 U.S. gal/min at max. control flow
 Relief valve setting24.5 MPa 250 kgf/cm² 3,550 psi
 Hydraulic cylinders:
 TypeDouble-acting, piston type
 Number of cylinders2
 Bore x stroke100 mm x 486 mm 3.9" x 19.1"

Loader control:
 Hydraulic pumpPiston pump
 Capacity321 ltr/min 84.8 U.S. gal/min at rated rpm
 Relief valve setting34.3 MPa 350 kgf/cm² 4,980 psi
 Hydraulic cylinders:
 TypeDouble-acting, piston type
 Number of cylinders—bore x stroke:
 Boom cylinder2- 160 mm x 898 mm 6.3" x 35.4"
 Bucket cylinder1- 185 mm x 675 mm 7.3" x 26.6"

Control valve2-spool type
 Control positions:
 BoomRaise, hold, lower, and float
 BucketTilt-back, hold, and dump
 Hydraulic cycle time (rated load in bucket)
 Raise7.2 sec
 Dump1.7 sec
 Lower (Empty)4.2 sec



SERVICE REFILL CAPACITIES

Cooling system120 ltr 31.7 U.S. gal
 Fuel tank473 ltr 124.9 U.S. gal
 Engine45 ltr 11.9 U.S. gal
 Hydraulic system337 ltr 89.0 U.S. gal
 Axle front87 ltr 22.9 U.S. gal
 rear81 ltr 21.4 U.S. gal
 Torque converter and transmission76 ltr 20.0 U.S. gal



BUCKET SELECTION GUIDE

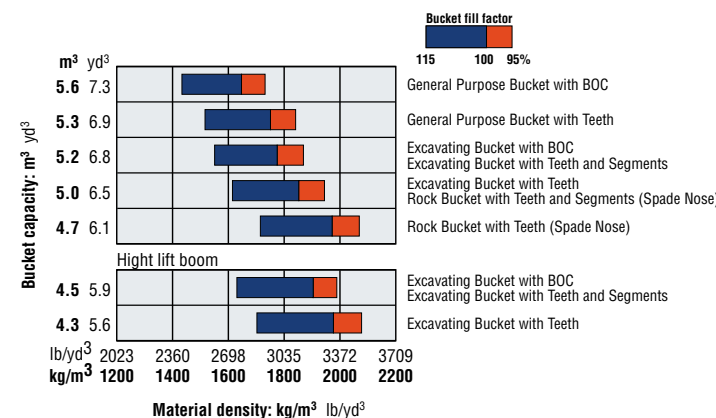

DIMENSIONS

Measured with 29.5-25-22PR (L3) tires

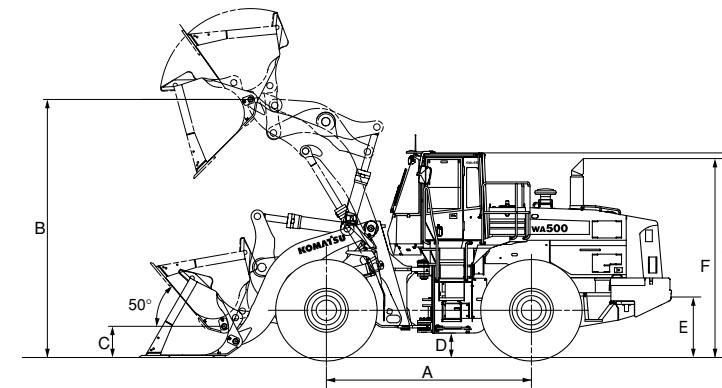

Tread	2400 mm	7'10"
Width over tires	3190 mm	10'6"
A Wheelbase	3780 mm	12'5"
B Hinge pin height, max. height	4755 mm	15'7"
C Hinge pin height, carry position	575 mm	1'11"
D Ground clearance	450 mm	1'6"
E Hitch height	1115 mm	3'8"
F Overall height, top of the stack	3665 mm	12'0"
G Overall height, ROPS cab	3785 mm	12'5"

	Standard boom						High lift boom			
	General Purpose Buckets		Excavating Buckets		Rock Buckets		Excavating Buckets			
	Straight edge Bolt-on Cutting edges	Straight edge Teeth	Straight edge Bolt-on Cutting edges	Straight edge Teeth and Segments	Straight edge Teeth	Spade nose Teeth and Segments	Spade nose Teeth	Straight edge Bolt-on Cutting edges	Straight edge Teeth and Segments	Straight edge Teeth
Bucket capacity: heaped	5.6 m ³ 7.3 yd ³	5.3 m ³ 6.9 yd ³	5.2 m ³ 6.8 yd ³	5.2 m ³ 6.8 yd ³	5.0 m ³ 6.5 yd ³	5.0 m ³ 6.5 yd ³	4.7 m ³ 6.1 yd ³	4.5 m ³ 5.9 yd ³	4.5 m ³ 5.9 yd ³	4.3 m ³ 5.6 yd ³
struck	4.8 m ³ 6.3 yd ³	4.5 m ³ 5.9 yd ³	4.2 m ³ 5.5 yd ³	4.2 m ³ 5.5 yd ³	4.0 m ³ 5.2 yd ³	4.0 m ³ 5.2 yd ³	4.0 m ³ 5.2 yd ³	3.7 m ³ 4.8 yd ³	3.7 m ³ 4.8 yd ³	3.5 m ³ 4.6 yd ³
Bucket width	3400 mm 11'2"	3460 mm 11'4"	3400 mm 11'2"	3460 mm 11'4"	3460 mm 11'4"	3460 mm 11'4"	3460 mm 11'4"	3400 mm 11'2"	3460 mm 11'4"	3460 mm 11'4"
Bucket weight	3005 kg 6,625 lb	2850 kg 6,285 lb	2870 kg 6,325 lb	2960 kg 6,525 lb	2715 kg 5,990 lb	3717 kg 8,195 lb	3460 kg 7,630 lb	2795 kg 6,160 lb	2885 kg 6,360 lb	2640 kg 5,820 lb
Dumping clearance, max. height and 45° dump angle*	3295 mm 10'10"	3165 mm 10'5"	3395 mm 11'2"	3265 mm 10'9"	3265 mm 10'9"	3030 mm 9'11"	3030 mm 9'11"	3890 mm 12'9"	3920 mm 12'10"	3920 mm 12'10"
Reach at max. height and 45° dump angle*	1500 mm 4'11"	1600 mm 5'3"	1400 mm 4'7"	1495 mm 4'11"	1495 mm 4'11"	1725 mm 5'8"	1725 mm 5'8"	1435 mm 4'8"	1405 mm 4'7"	1405 mm 4'7"
Reach at 2130 mm (7") clearance and 45° dump angle	2300 mm 7'7"	2340 mm 7'8"	2215 mm 7'3"	2285 mm 7'6"	2285 mm 7'6"	2400 mm 7'10"	2400 mm 7'10"	2585 mm 8'6"	2645 mm 8'8"	2645 mm 8'8"
Reach with arm horizontal and bucket level	3265 mm 10'9"	3425 mm 11'3"	3120 mm 10'3"	3280 mm 10'9"	3280 mm 10'9"	3610 mm 11'10"	3610 mm 11'10"	3385 mm 11'1"	3545 mm 11'8"	3545 mm 11'8"
Operating height (fully raised)	6430 mm 21'1"	6430 mm 21'1"	6415 mm 21'1"	6415 mm 21'1"	6415 mm 21'1"	6630 mm 21'9"	6630 mm 21'9"	6715 mm 22'0"	6715 mm 22'0"	6715 mm 22'0"
Overall length	9815 mm 32'2"	9975 mm 32'9"	9670 mm 31'9"	9790 mm 32'1"	9790 mm 32'1"	10155 mm 33'4"	10155 mm 33'4"	10030 mm 32'11"	10190 mm 33'5"	10190 mm 33'5"
Loader clearance circle (bucket at carry, outside corner of bucket)	7650 mm 25'1"	7730 mm 25'3"	7610 mm 24'12"	7690 mm 25'3"	7690 mm 25'3"	7645 mm 25'1"	7645 mm 25'1"	7805 mm 25'7"	7890 mm 25'11"	7890 mm 25'11"
Digging depth: 0°	135 mm 5"	155 mm 6"	135 mm 5"	155 mm 6"	155 mm 6"	165 mm 6"	165 mm 6"	210 mm 8"	235 mm 9"	235 mm 9"
10°	435 mm 1'5"	485 mm 1'7"	410 mm 1'4"	460 mm 1'6"	460 mm 1'6"	525 mm 1'9"	525 mm 1'9"	470 mm 1'7"	520 mm 1'8"	520 mm 1'8"
Static tipping load: straight	23450 kg 51,700 lb	23650 kg 52,140 lb	23600 kg 52,030 lb	23490 kg 51,785 lb	23805 kg 52,480 lb	23055 kg 50,830 lb	23380 kg 51,545 lb	21555 kg 47,520 lb	21440 kg 47,265 lb	21745 kg 47,940 lb
40° full turn	20400 kg 44,975 lb	20575 kg 45,360 lb	20500 kg 45,195 lb	20405 kg 44,985 lb	20680 kg 45,590 lb	19320 kg 42,595 lb	19595 kg 43,200 lb	18750 kg 41,335 lb	18650 kg 41,115 lb	18915 kg 41,700 lb
Breakout force	245 kN 25000 kgf 55,115 lb	262 kN 26750 kgf 58,975 lb	268 kN 27300 kgf 60,185 lb	274 kN 27950 kgf 61,620 lb	288 kN 29400 kgf 64,815 lb	233 kN 23800 kgf 52,470 lb	243 kN 24750 kgf 54,565 lb	286 kN 29140 kgf 64,245 lb	294 kN 30000 kgf 66,140 lb	310 kN 31620 kgf 69,710 lb
Operating weight	32150 kg 70,880 lb	31995 kg 70,535 lb	32070 kg 70,700 lb	32160 kg 70,900 lb	31915 kg 70,360 lb	32850 kg 72,420 lb	32605 kg 71,880 lb	33170 kg 73,125 lb	33260 kg 73,325 lb	33015 kg 72,785 lb

* At the end of tooth or B.O.C.

All dimensions, weights, and performance values based on SAE J732c and J742b standards.

Static tipping load and operating weight shown include lubricant, coolant, full fuel tank, ROPS cab, and operator. Machine stability and operating weight affected by counterweight, tire size, and other attachments.

Apply the following weight changes to operating weight and static tipping load.